

Scan and Login website
for more information



TIP BOOK

DentalDeal



Contents

Periodontal treatment device

Dimensions Unit: mm

Model			Page
P50L			1
P50R			2
P52			3
P53L			4
P53R			5

Model			Page
P54L			6
P54R			7
P58			8

Periodontal treatment device

Model		Page
P56		9
P59		10
P80		11
P90		12
P94		13

Periodontal treatment device

Dimensions Unit: mm

Model		Page
P95		14

Scaling

Model		Page
G1		15
G2		16
G3		17
G4		18

Scaling

Model		Page
G5		19
G6		20
G7		21
G8		22
G9		23
G10		24

Scaling

Model		Page
G11		25
G12		26

Dimensions Unit: mm

Inlay Preparation

Model		Page
G20		27
G21		28
G30		29

Inlay Preparation

Model		Page
G31		30
G32		31
G33		32

Periodontics

単位: mm

Model		Page
P1		33
P2L		34

Periodontics

Dimensions Unit: mm

Model		Page
P2LD		35
P2R		36
P2RD		37
P3		38

Periodontics

Model		Page
P3L		39

Periodontics

Model		Page
P3R		40
P3D		41
P4		42
P5		43
P6		44

Model		Page
P7		45
P8		46
P10		47
P11		48
P12		49

Dimensions Unit: mm

Periodontics

Model		Page
P14L		50
P14R		51
P18		52
P20		53
P20L		54
P20R		55

Dimensions Unit: mm

Model		Page
P21L		56
P21R		57
P22L		58
P22R		59
P33		60

Periodontics

Model		Page
PD40		61
PD41		62
PD42		63

Endodontics

Model		Page
E1		64
E2		65

Dimensions Unit: mm

Model		Page
E3		66
E3D		67
E4		68
E4D		69

Endodontics

Model		Page
E5		70
E5D		71
P4D		72
E6		73

Model		Page
E7		74
E8		75
E9		76
E10		77
E10D		78

Endodontics

Model		Page
E11		79
E11D		80
E12D		81
E14		82

Model		Page
E14D		83
E15		84
E15D		85
ED17		86

Endodontics

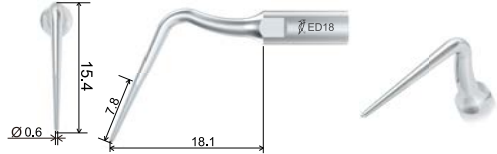
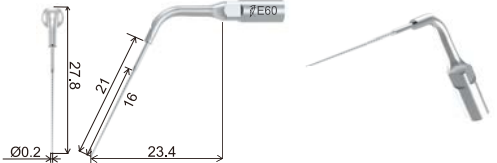
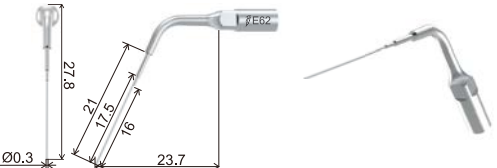
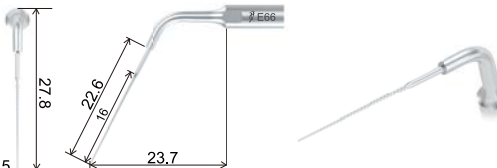
Model	Page
 <p>ED18</p>	87
 <p>E60</p>	88
 <p>E62</p>	89
 <p>E66</p>	90

Cavity preparation

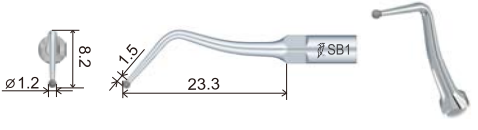
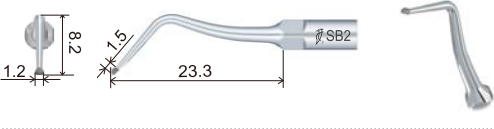
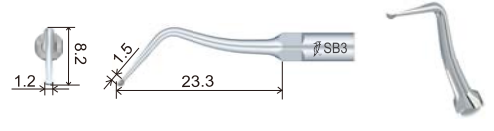
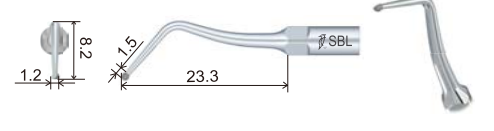
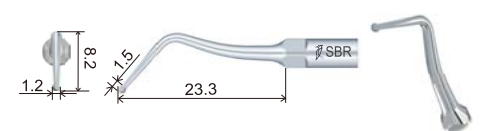

Dimensions Unit: mm

Model	Page
 <p>SB1</p>	91
 <p>SB2</p>	92
 <p>SB3</p>	93
 <p>SBL</p>	94
 <p>SBR</p>	95

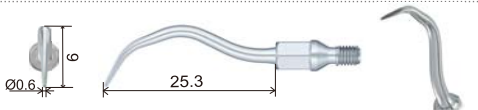
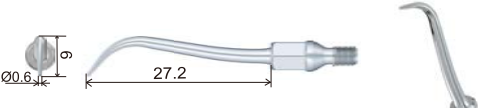
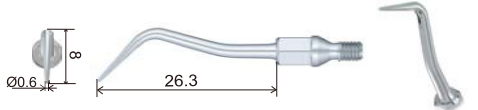
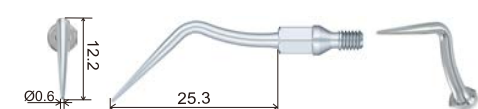
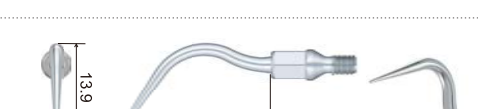
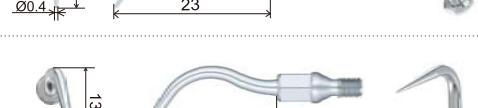
Scaling

Model		Page
GK1		96
GK2		97
GK3		98
GK4		99
GK5		100
GK6		101

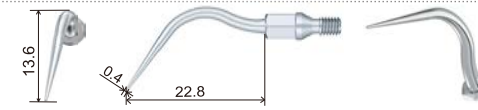
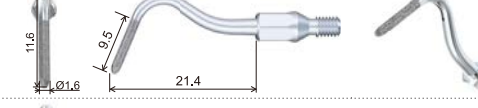
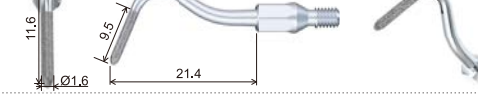
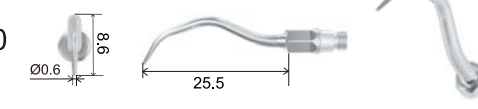
Dimensions Unit: mm

Model		Page
GK7		102
GK20		103
GK21		104
GK60		105
GK61		106
GK62		107

Scaling

Model	Page
<p>GC1</p>	108
<p>GC2</p>	109

Periodontics

Model	Page
<p>PC1</p>	110
<p>PC60</p>	111
<p>PC61</p>	112

Periodontics

Dimensions Unit: mm

Model	Page
<p>PC62</p>	113

Scaling

Model	Page
<p>A1</p>	114
<p>A2</p>	115

P50L

Volume of water: Ensure the cooling water reach the end of the tip.

Functional Description: Explore subgingival calculus, root planing and subgingival scaling.

Applicable area: Teeth adjacent part

Operation method: The tip is perpendicular to the long axis of the tooth, The front or back 2mm tip needle part adapt the tooth surface. Move the tip up and down.

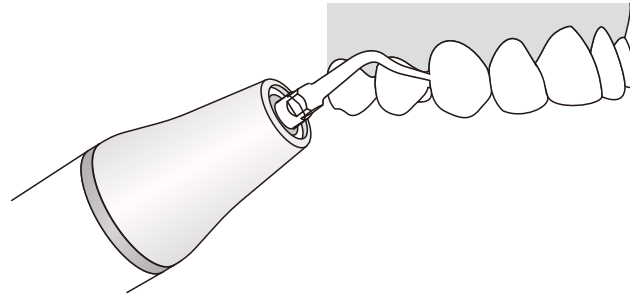

Demo Video

MODE: P
POWER

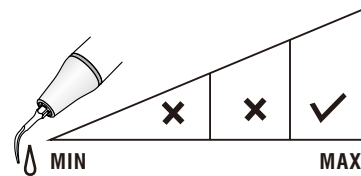
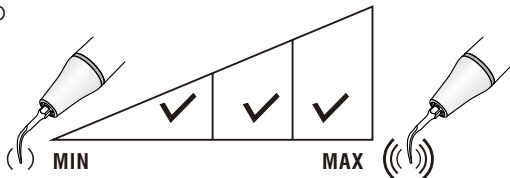

IRRIGATION

P50R

Volume of water: Ensure the cooling water reach the end of the tip.

Functional Description: Explore subgingival calculus, root planing and subgingival scaling.

Applicable area: Teeth adjacent part

Operation method: The tip is perpendicular to the long axis of the tooth, The front or back 2mm tip needle part adapt the tooth surface. Move the tip up and down.

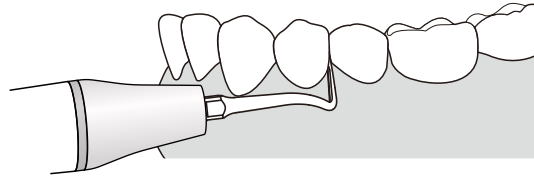

Demo Video

MODE: P

POWER

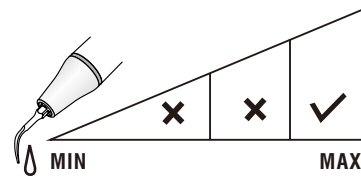
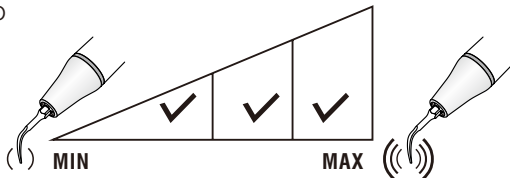

IRRIGATION

P52

Volume of water: Ensure the cooling water reach the end of the tip

Functional Description: For gingival scaling

Applicable area: All teeth buccal and lingual site

Operation method: The tip is parallel to the long axis of the tooth, and ensure the 2 mm right or left tip middle site adapt the tooth surface. Move the tip front and back.

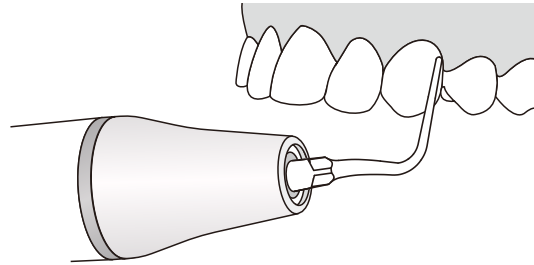
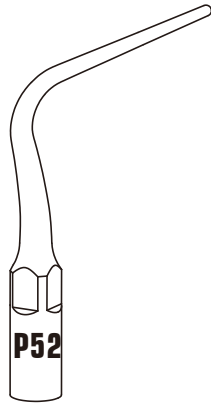

Demo Video

MODE: P

POWER

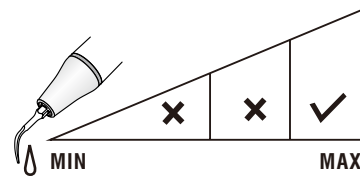
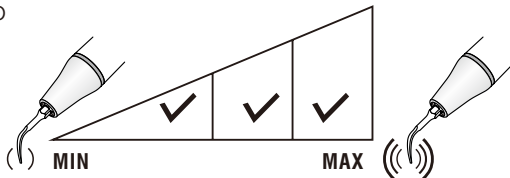

IRRIGATION

P53L

Volume of water: Ensure the cooling water reach the end of the tip.

Functional Description: Explore subgingival calculus, root planing and subgingival scaling.

Applicable area: Teeth adjacent part

Operation method: The tip is perpendicular to the long axis of the tooth, The front or back 2mm tip needle part adapt the tooth surface. Move the tip up and down.

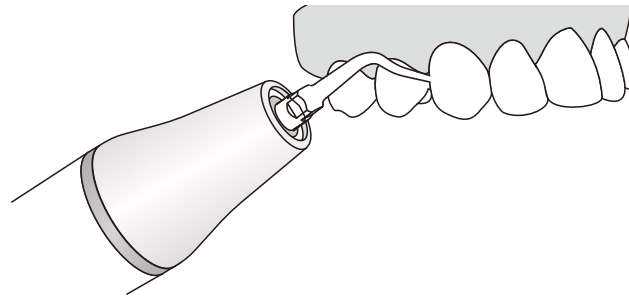

**MODE: P
POWER**

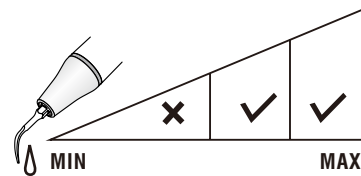
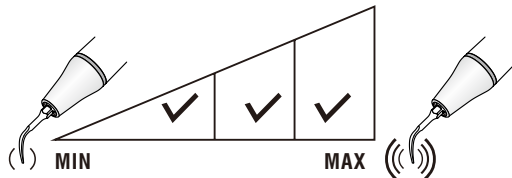

IRRIGATION

P53R

Volume of water: Ensure the cooling water reach the end of the tip.

Functional Description: Explore subgingival calculus, root planing and subgingival scaling.

Applicable area: Teeth adjacent part

Operation method: The tip is perpendicular to the long axis of the tooth, The front or back 2mm tip needle part adapt the tooth surface. Move the tip up and down.

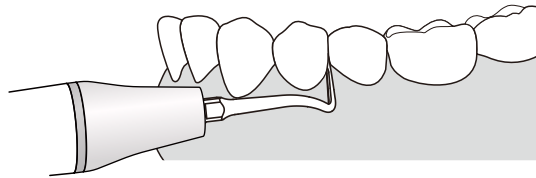
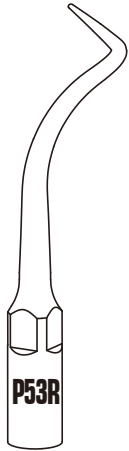

MODE: P
POWER

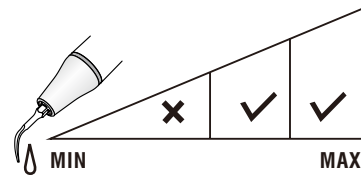
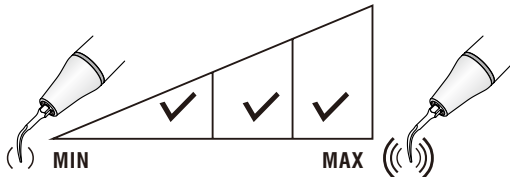

IRRIGATION

P54L

Water volume control: Ensure that the cooling water reaches the end of the tip

Function: For the treatment of root bifurcation area.

Applicable area: Root bifurcation area

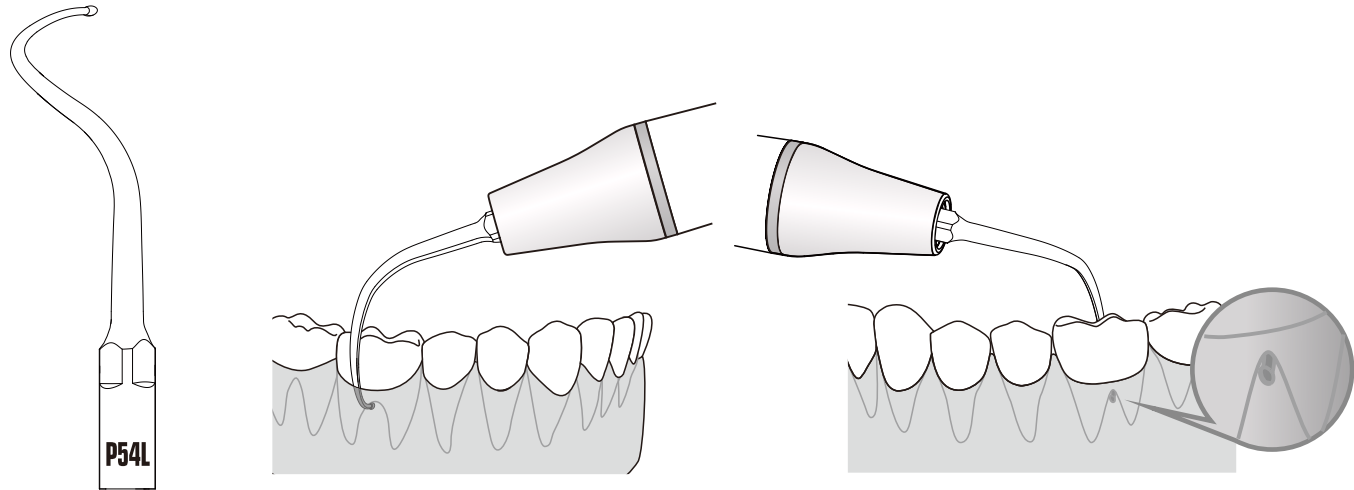

MODE: P
POWER

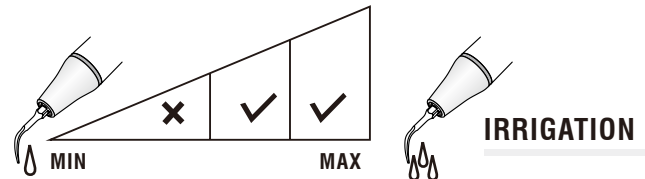
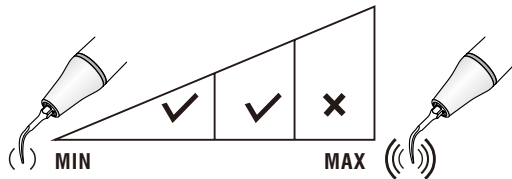

P54R

Water volume control: Ensure that the cooling water reaches the end of the tip

Function: For the treatment of root bifurcation area.

Applicable area: Root bifurcation area

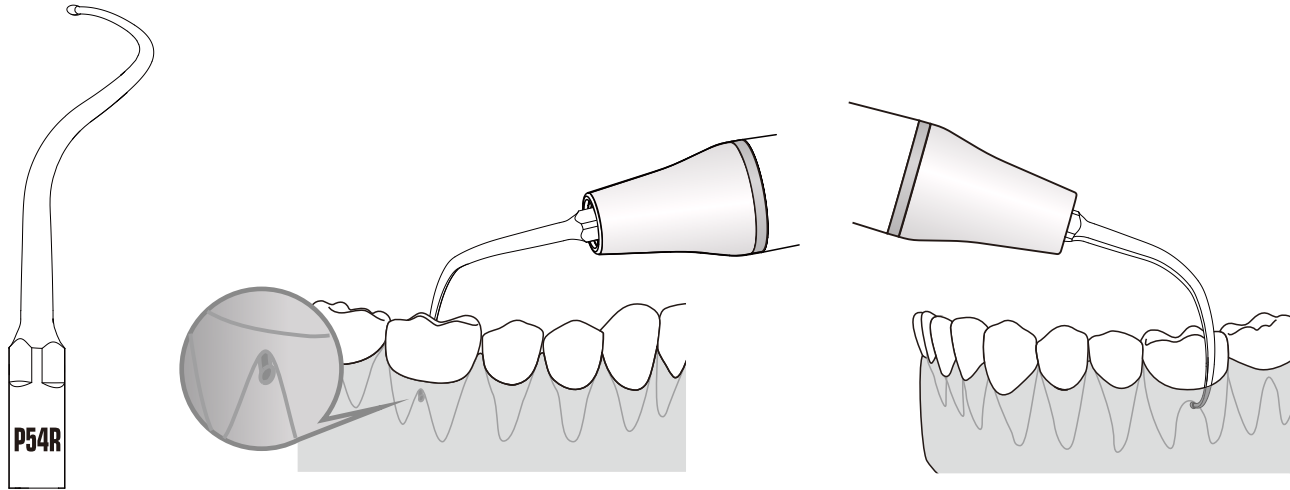

MODE: P
POWER

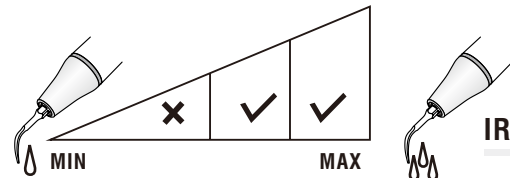
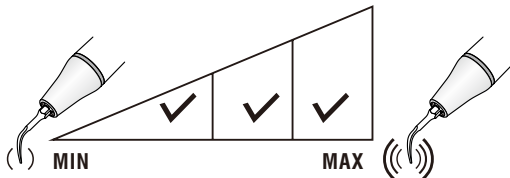

IRRIGATION

P56

Volume of water: Ensure the cooling water reach the end of the tip

Functional Description: Used for gingival large stones and dental plaque

Applicable area: All teeth buccal and lingual site.

Operation method: The tip is parallel to the long axis of the tooth. and ensure the 2 mm right or left tip niddle site adapt the tooth surface. Move the tip front and back.

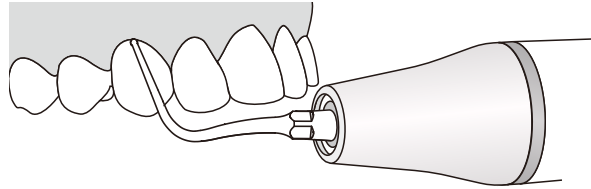
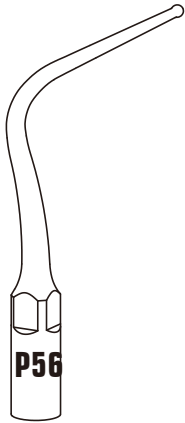

MODE: P
POWER

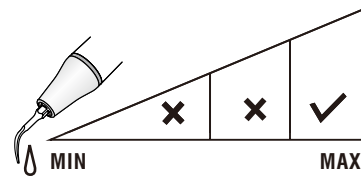
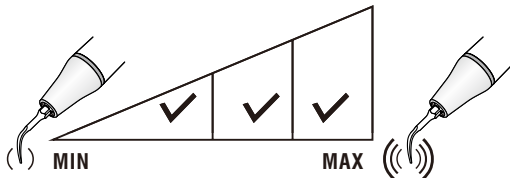

IRRIGATION

P58

Water volume control: Ensure that the cooling water reaches the end of the tip.

Function: For the treatment of root bifurcation, removal of supragingival large calculus and plaque.

Applicable area: root bifurcation area, labial (buccal) surface and lingual (palatal) surface of all teeth.

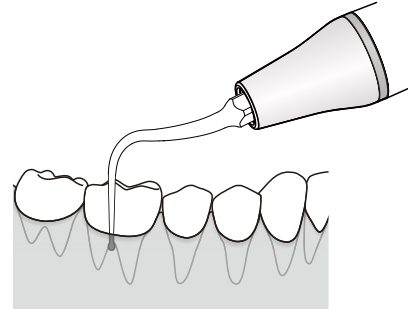
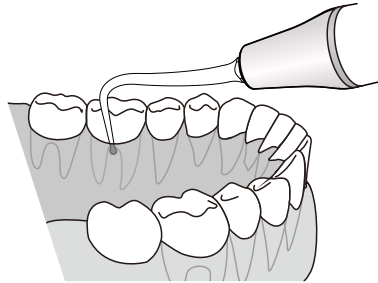

MODE: P
POWER

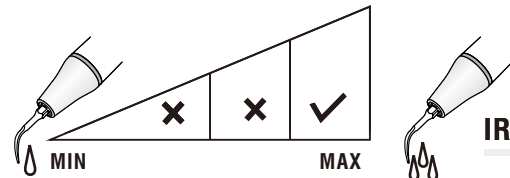
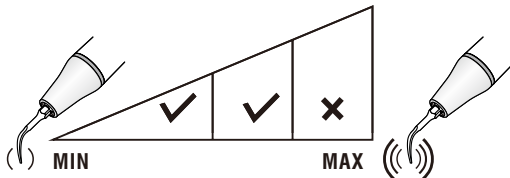

IRRIGATION

P59

Volume of water: Ensure the cooling water reach the end of the tip

Functional Description: For subgingival calculus probing, subgingival scaling and root planing

Applicable area: All teeth buccal and lingual site

Operation method: The tip is parallel to the long axis of the tooth. and ensure the 2 mm right or left tip middle site adapt the tooth surface. Move the tip front and back.

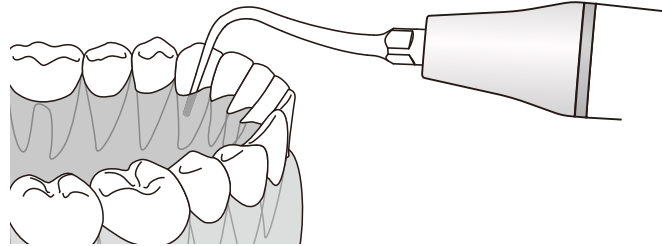

Demo Video

MODE: P

POWER

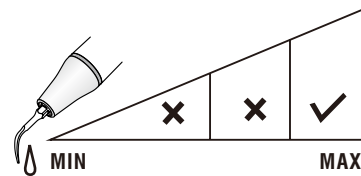
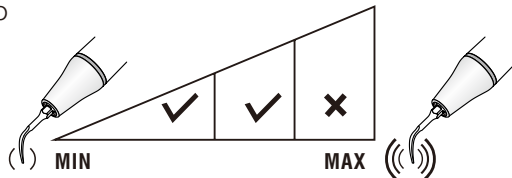

IRRIGATION



P80

Function: For subgingival irrigation. It is mainly used to rinse out the residue after the subgingival treatment.

Features: For non-invasive irrigation. The water outlet is at about 1 mm from the tip, which is convenient for subgingival flushing at different areas and angles.

Use: Used in P mode of PT5. Recommended power level: level 1~5 (Please do not exceed the recommended maximum power level. Otherwise instrument fracture is easy to happen).

Note:

- (1) The tip is mainly used for subgingival irrigation, and should not be used for scraping solid objects as much as possible to prevent the tip from being worn too fast and shortening the service life.
- (2) In order to ensure the safety, it is recommended to firstly perform the external debugging, select debugging water volume under power level 1, ensure the water output is normal, and adjust the power within the range of power level limit.

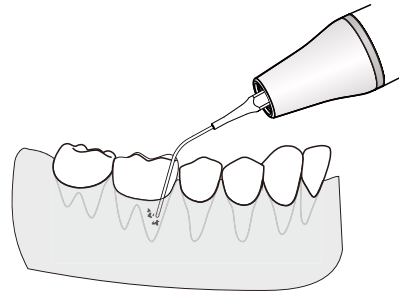
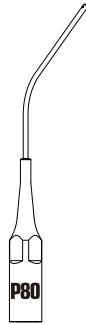

MODE: P
POWER

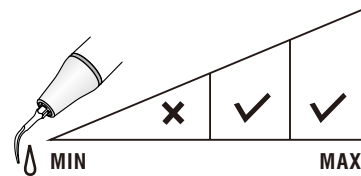
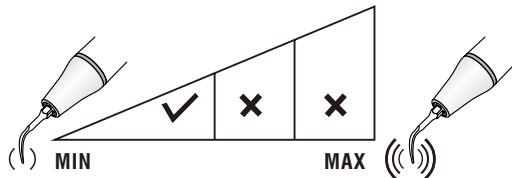

IRRIGATION

P90

Volume of water: Ensure the cooling water reach the end of the tip

Functional Description: Used for gingival large stones and dental plaque

Applicable area: All teeth buccal and lingual site of dental implant or prosthesis.

Operation method: The tip is parallel to the long axis of the tooth, and ensure the 2 mm right or left tip middle site adapt the tooth surface. Move the tip front and back.

Warn: Please ensure that there is water coming out from the handpiece to avoid damage to the tip

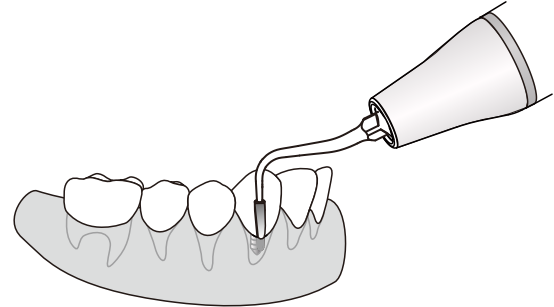
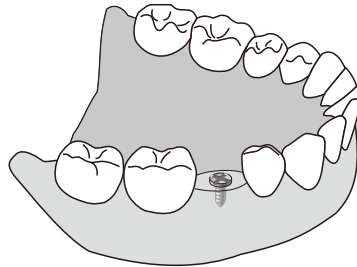

MODE: P
POWER

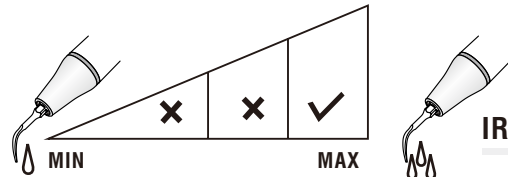
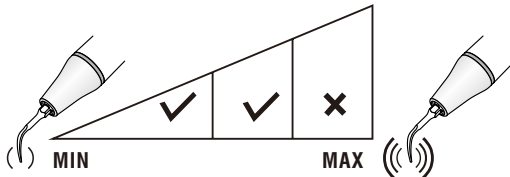

IRRIGATION

P94

Function: Cleaning and maintenance of implant

Size: Plastic head is of 15mm length

Features: The tip is of a slender hook shape, making it easier for subgingival cleaning and maintenance.

Use:

- a. Used in P mode of Periodontal Treatment Device. Recommended power level: level 1~3.
- b. Used in P mode of U600. Recommended power level: level 1
- c. Used in P mode of U6. Recommended power level: level 1~3.

Note:

- (1) The plastic part is made of PEEK material which can be disinfected under high temperature and high pressure, the higher the power, the easier it is to wear;
- (2) Avoid the tip stuck in the gap of the tooth during operation to avoid breaking the tip.

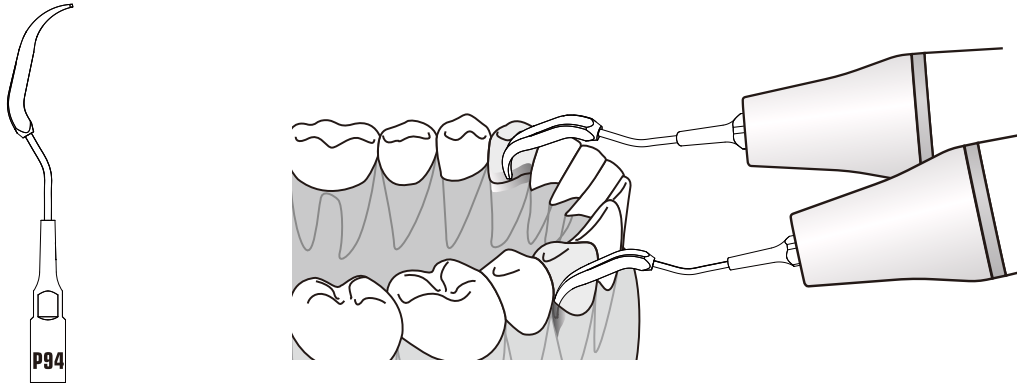

MODE: P
POWER

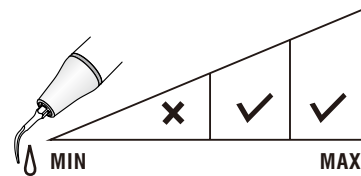
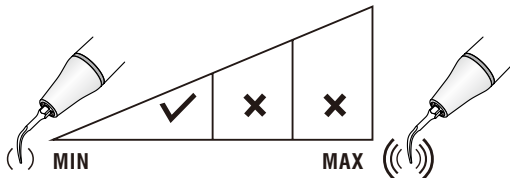

IRRIGATION

P95

Function: Cleaning and maintenance of implant

Size: Plastic head is of 19mm length

Features: The tip is of a slender hook shape, making it easier for subgingival cleaning and maintenance.

Use:

a. Used in P mode of Periodontal Treatment Device. Recommended power level: level 1~6.

b. Used in P mode of U600. Recommended power level: level 1~3

c. Used in P mode of U6. Recommended power level: level 1~6.

Note:

(1) The plastic part is made of PEEK material which can be disinfected under high temperature and high pressure, the higher the power, the easier it is to wear;

(2) Avoid the tip stuck in the gap of the tooth during operation to avoid breaking the tip.

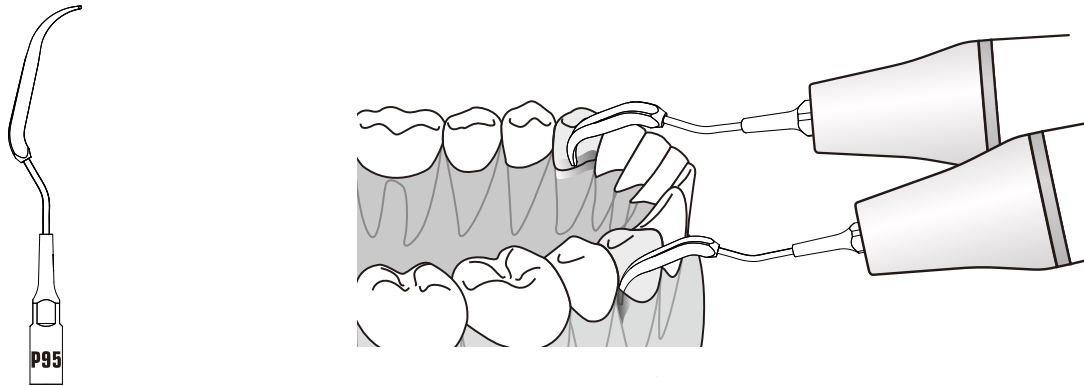

MODE: P
POWER

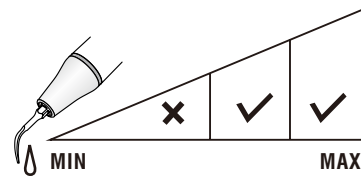
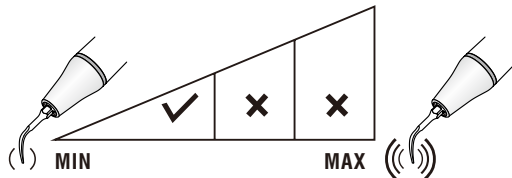

IRRIGATION

G1 (GD1/GS1)

Removal of supragingival deposits in all quadrants.

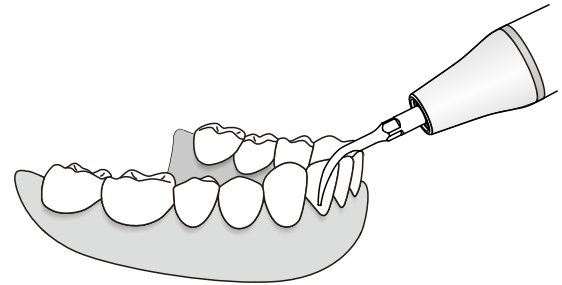
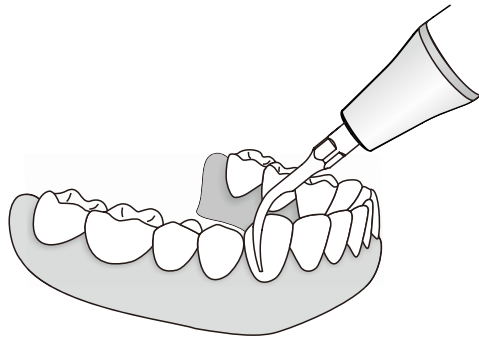
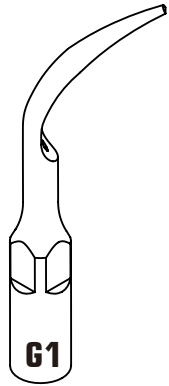

Demo Video

MODE: G
POWER

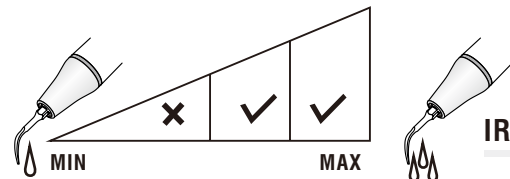
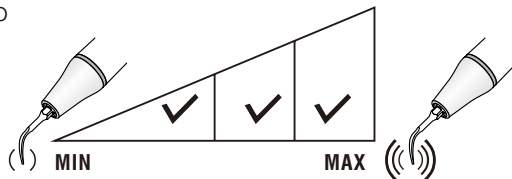

IRRIGATION

G2 (GD2/GS2)

Removal of heavy supragingival deposits.
Apply flat end to surface of teeth.

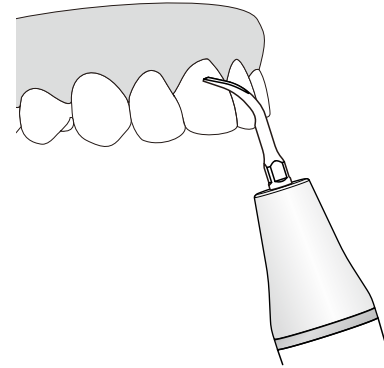
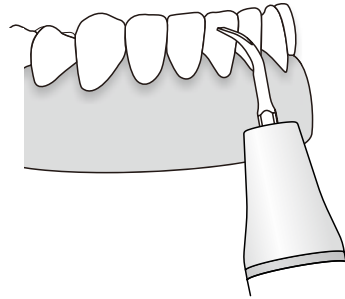
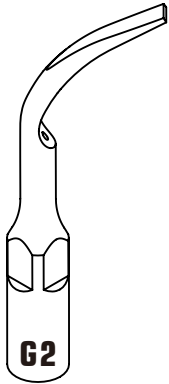

Demo Video

MODE: G
POWER

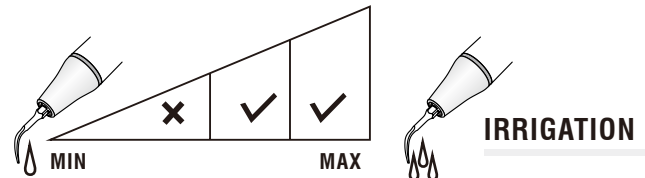
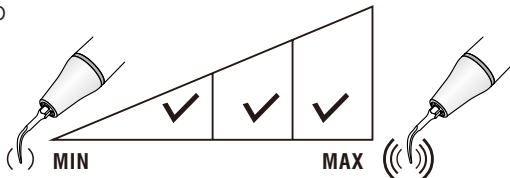

G3 (GD3/GS3)

Removal of supragingival deposits in all quadrants, including the interproximal and sulcus areas.

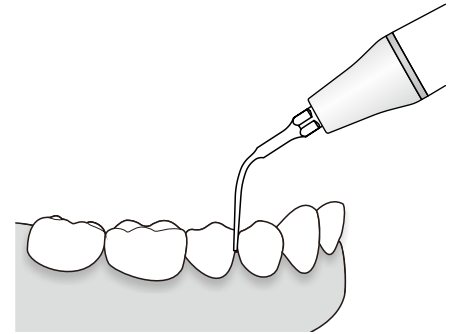
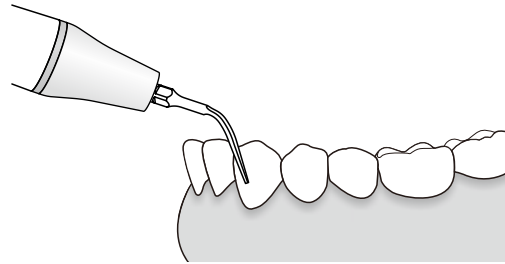
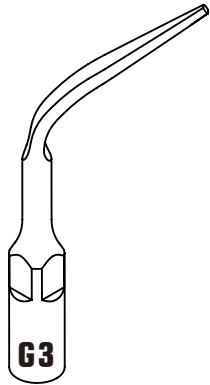

Demo Video

MODE: G
POWER

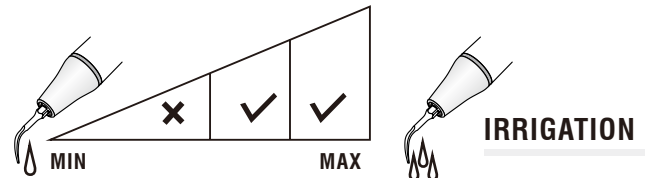
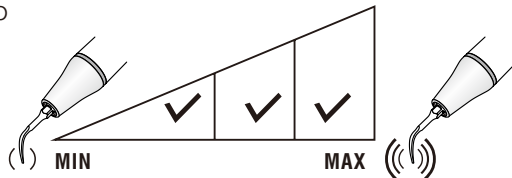

G4(GD4/GS4)

Recommended for the treatment of interproximal spaces and for supragingival scaling.

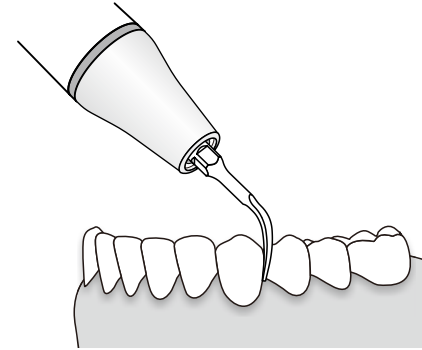
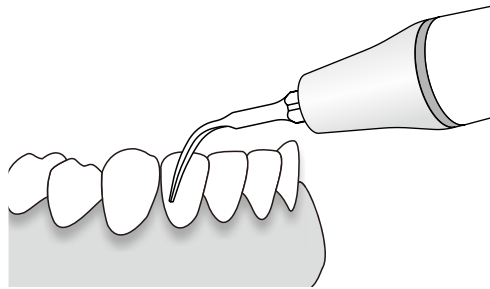
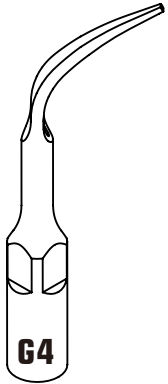

Demo Video

MODE: G
POWER

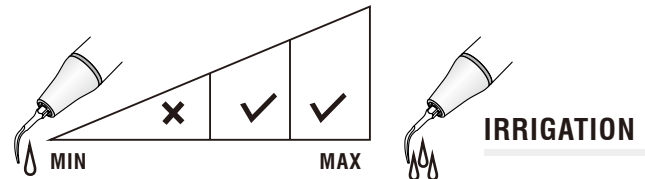
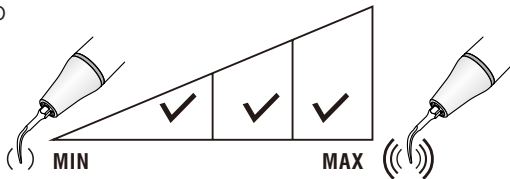

G5 (GD5/GS5)

Recommended for treating simple cases and gross supragingival scaling.

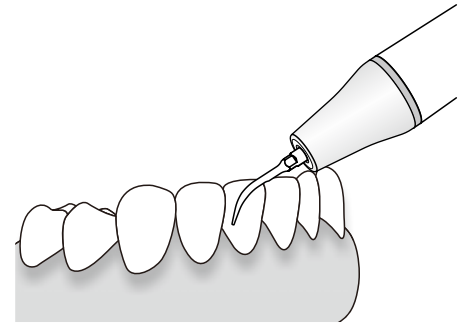
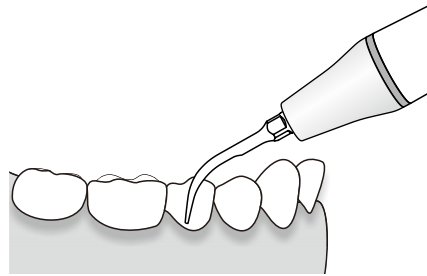
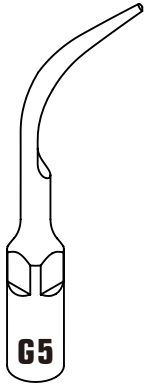

Demo Video

MODE: G
POWER

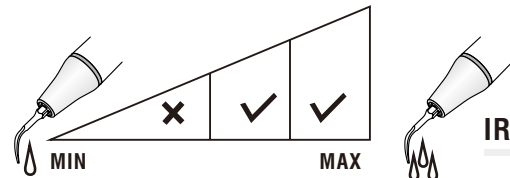
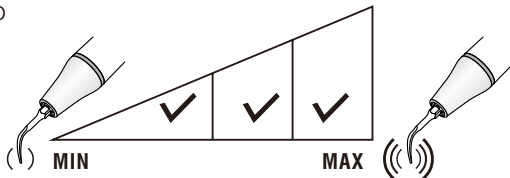

IRRIGATION

G6 (GD6/GS6)

Recommended for removing voluminous supragingival deposits.
Apply flat end to surface of teeth.

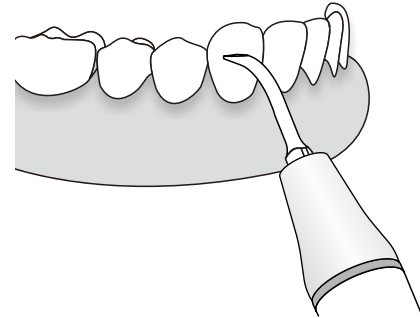
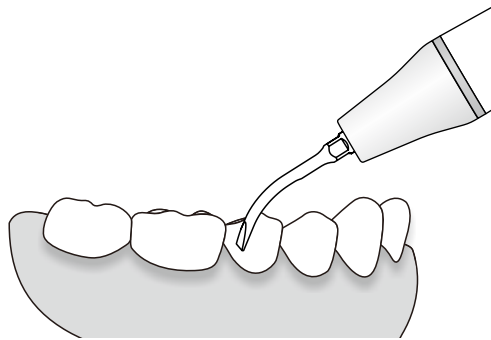
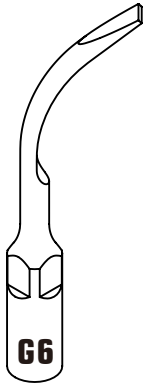

Demo Video

MODE: G
POWER

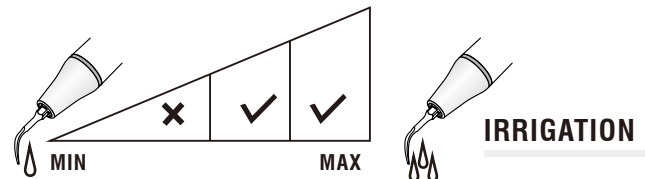
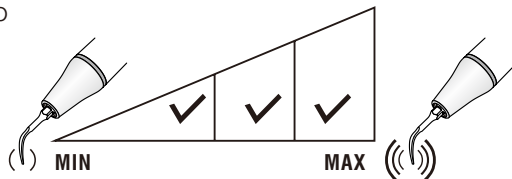

G7 (GD7/GS7)

Removal of crowns.

Apply the instrument onto surface and activate. Increase pressure until vibrations can no longer be heard and maintain for few seconds.

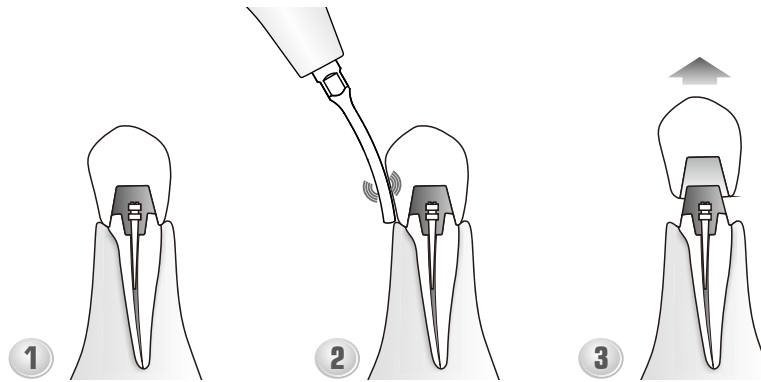
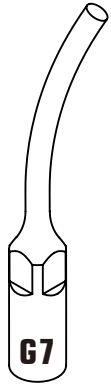

Demo Video

MODE: G
POWER

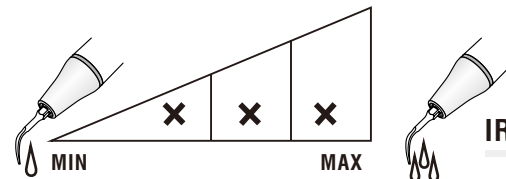
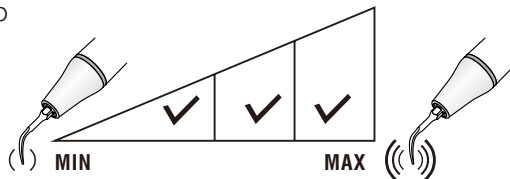

IRRIGATION

G8 (GD8/GS8)

Removal of posts.

Ultrasonic high efficiency for the removal of the difficult prosthetic parts.

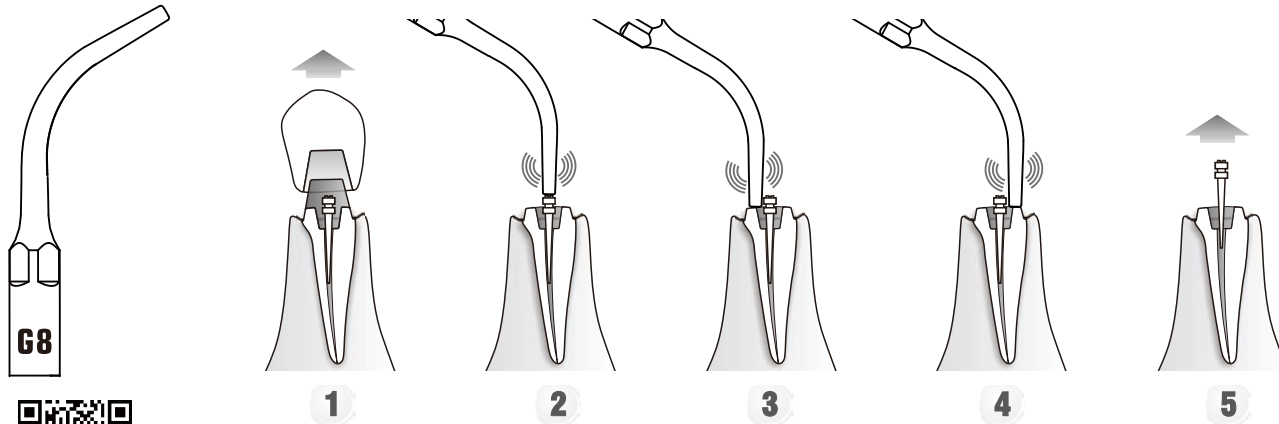

Demo Video

MODE: G
POWER

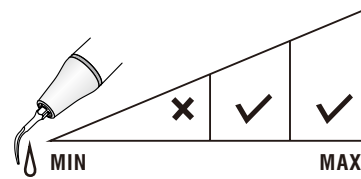
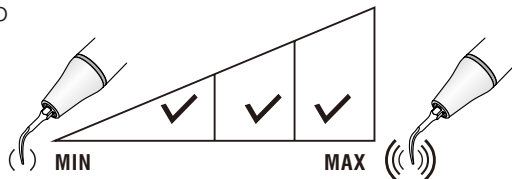

IRRIGATION

G9 (GD9)

Removal of supragingival calculus, interdental calculus and calculus at the neck of the teeth.



Demo Video

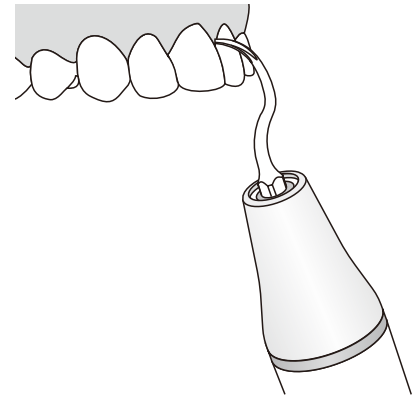
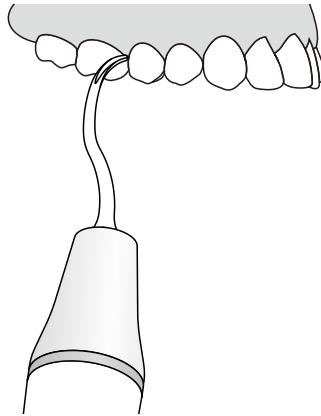

MODE: G
POWER

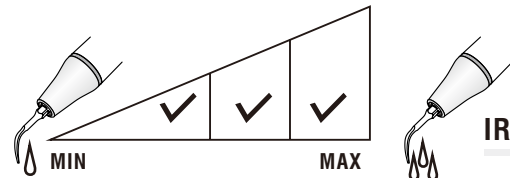
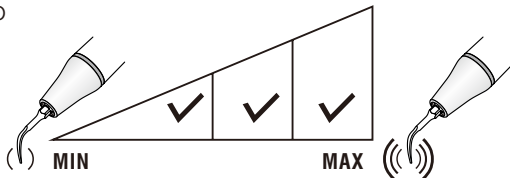

IRRIGATION

G10 (GD10)

Removal of supragingival deposits in all quadrants, including the interproximal and sulcus areas.

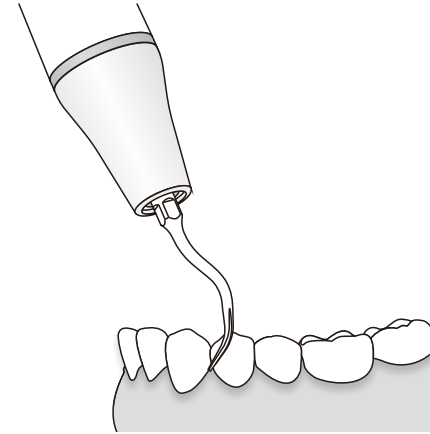
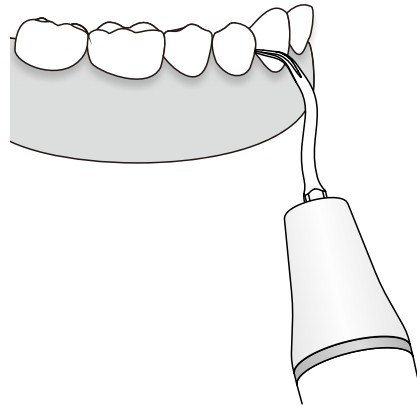

Demo Video

MODE: G
POWER

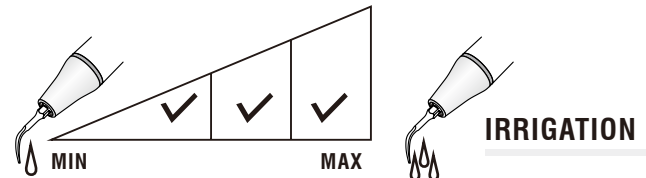
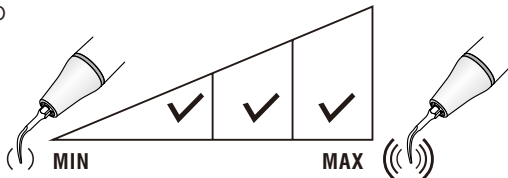

G11(GD11/GK11)

Diamond-coated(40µm) instrument for polishing the treatment surface of teeth in interproximal areas, without damaging the adjacent teeth during the orthodontics treatment.

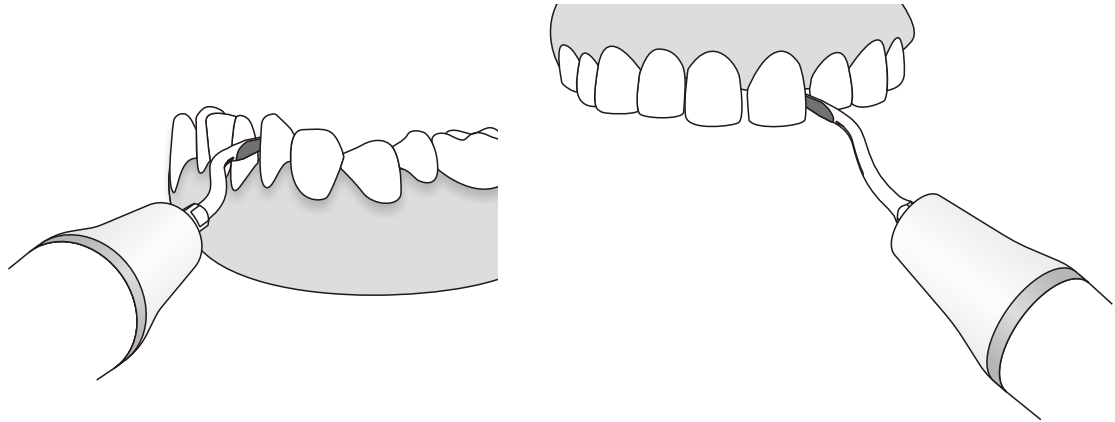

Demo Video

MODE: G
POWER

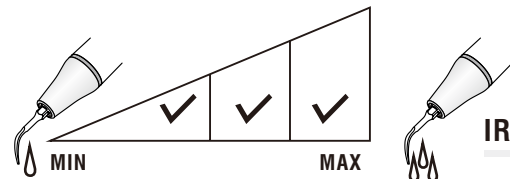
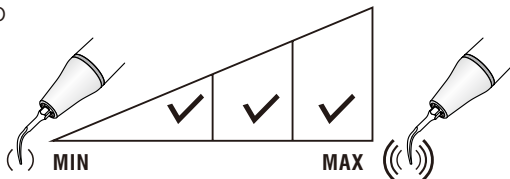

IRRIGATION

G12 (GD12)

Removal of large supragingival deposits on the lingual surfaces in all quadrants.

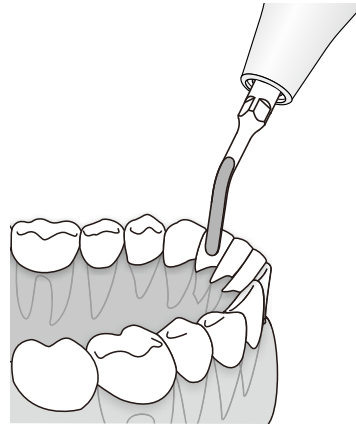
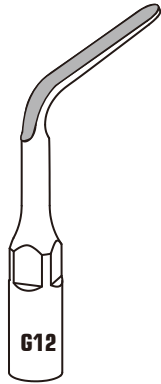

MODE: G
POWER

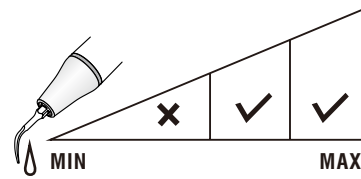
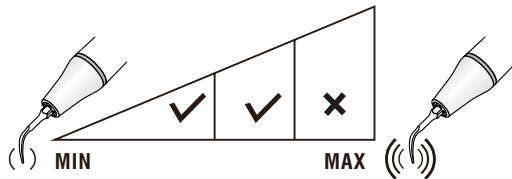

IRRIGATION

G20(GD20)

There are diamonds coated (120um grit) on the head of the tip for dentin abrading.

It's used for "supragingival shoulder" preparation after the completion of the preparation of the "subgingival shoulder" with bur.

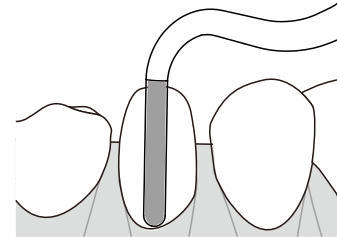
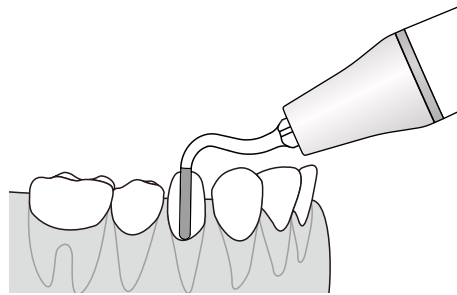

**MODE: G
POWER**

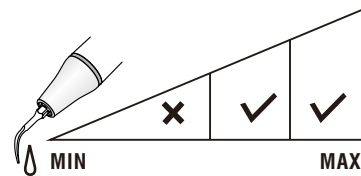
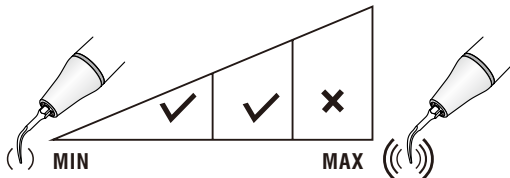

IRRIGATION

G21 (GD21)

There are diamonds coated (50um fine sand) on the head of the tip for dentin abrading, mainly used for polishing of prepared supragingival shoulder and subgingival shoulder.

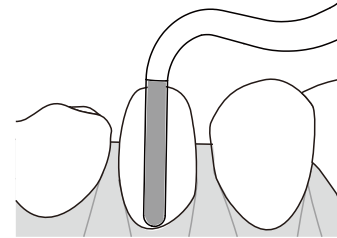
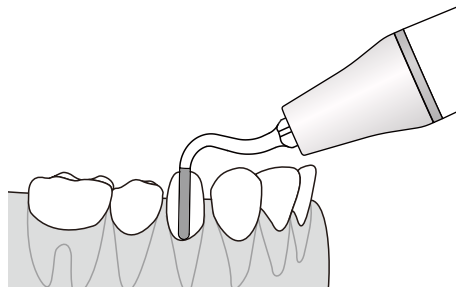

**MODE: G
POWER**

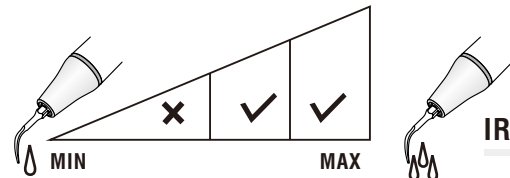
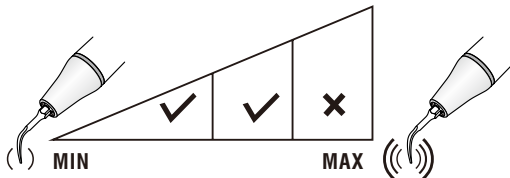

IRRIGATION

G30 (GD30)

There are diamonds coated (90um) on the head of the tip, used for the preparation between pits and fissures.

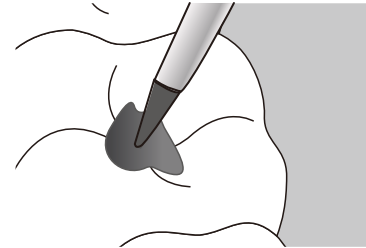
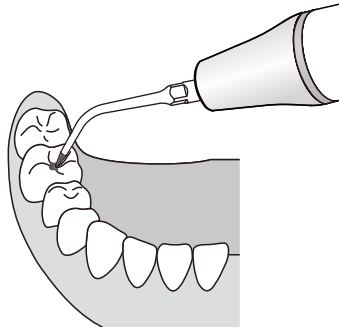
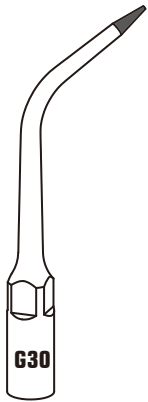

MODE: G
POWER

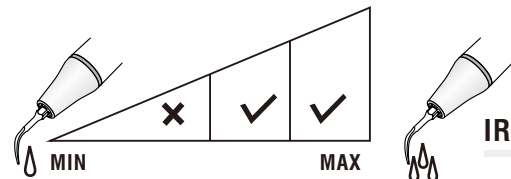
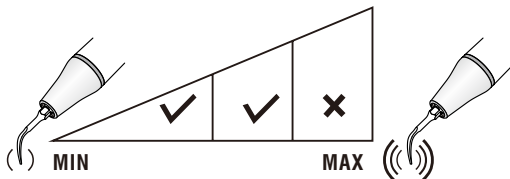

IRRIGATION

G31 (GD31)

There are diamonds coated (90um) on the head of the tip, used for the preparation of the mesial cavity.

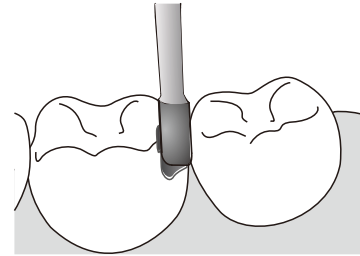
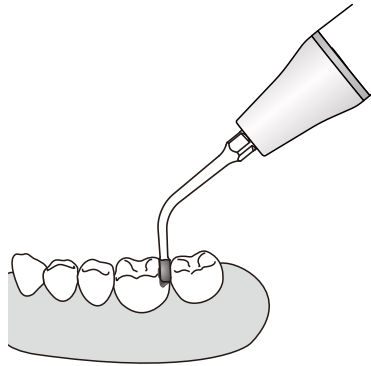

MODE: G
POWER

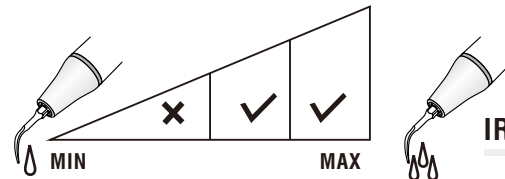
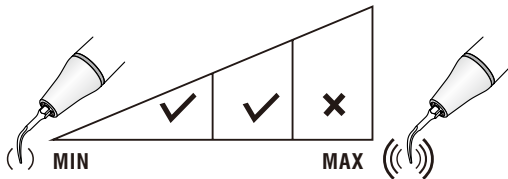

IRRIGATION

G32 (GD32)

There are diamonds coated (90um) on the head of the tip, used for the preparation of the distal cavity.

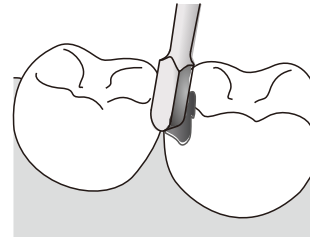
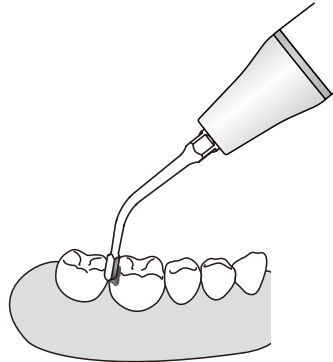
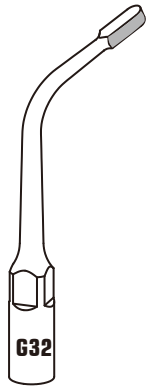

MODE: G
POWER

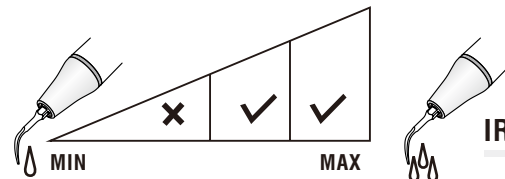
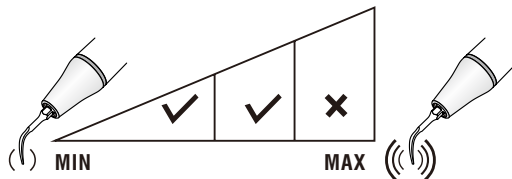

IRRIGATION

G33 (GD33)

There are diamonds coated (90um) on the head of the tip, used for the preparation of the tooth veneers.

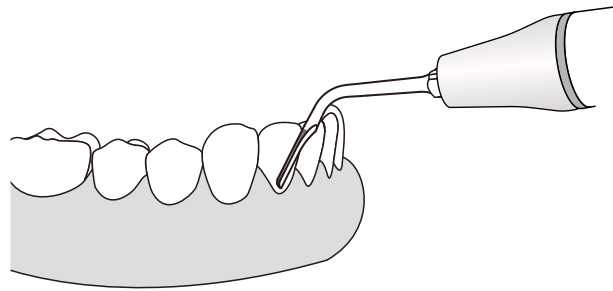
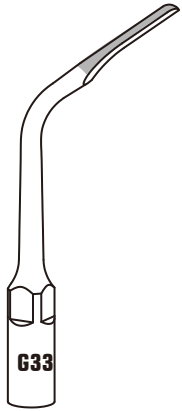

**MODE: G
POWER**

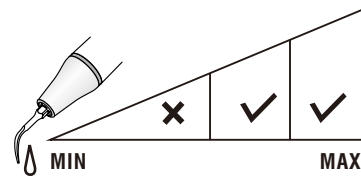
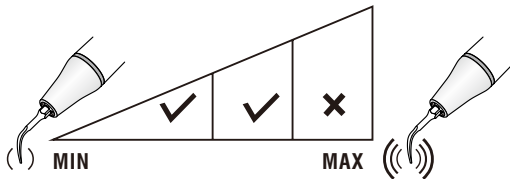

IRRIGATION

P1 (PD1/PS1)

Slim and sharp, recommended for cleaning and irrigating of subgingival deposits.

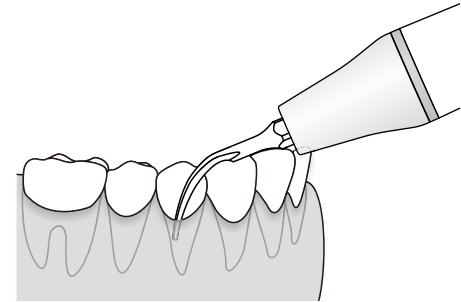
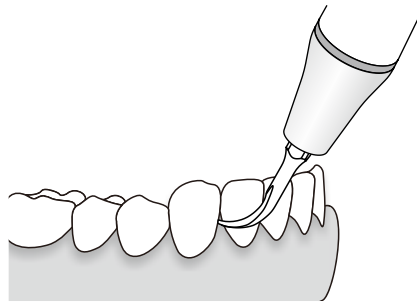
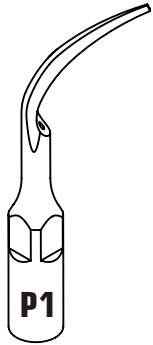

Demo Video

MODE: P
POWER

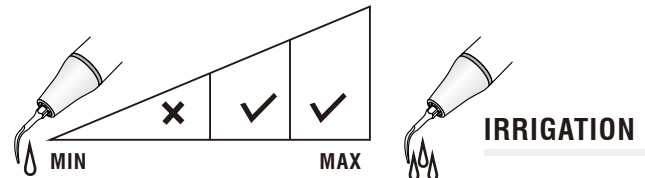
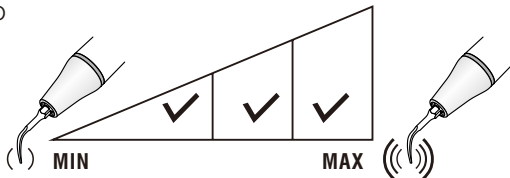

P2L(PD2L)

Left-angled, used to remove calculus from very narrow inter-root spaces and furcation.

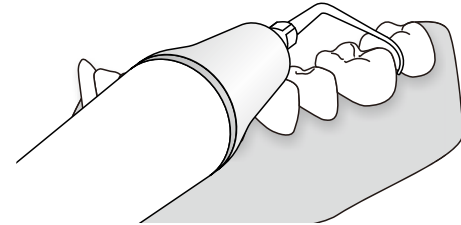
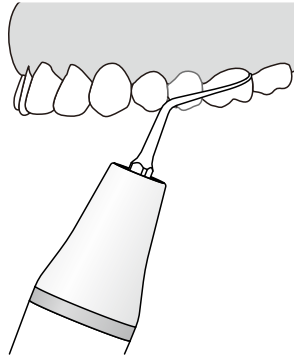
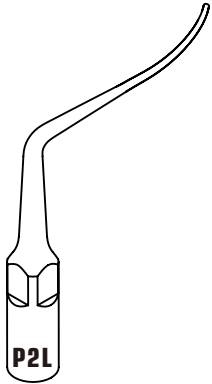

Demo Video

MODE: P
POWER

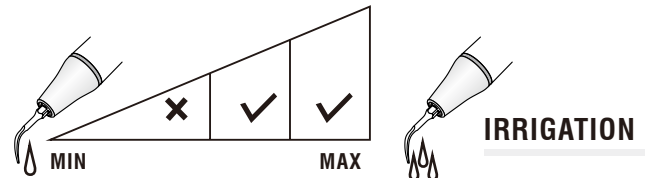
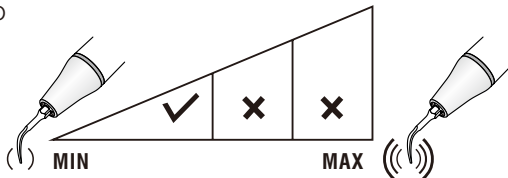

P2LD (PD2LD)

Left-angled, diamond-coated(40µm) instrument for root planing.

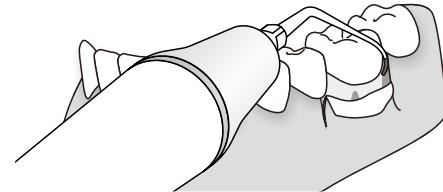
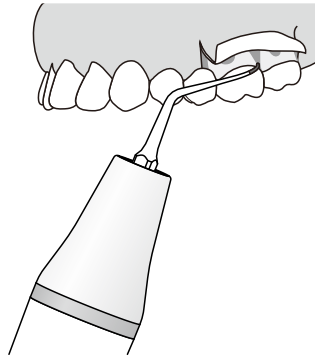
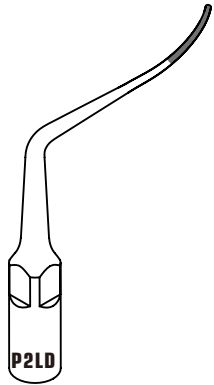

Demo Video

MODE: P
POWER

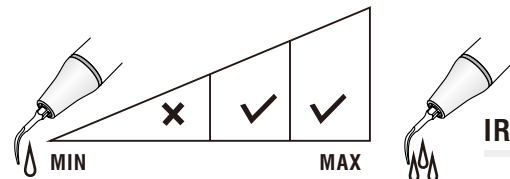
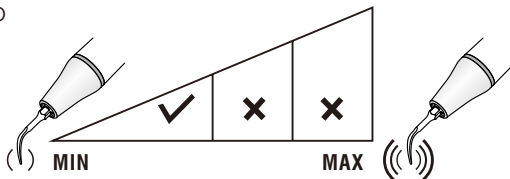

IRRIGATION

P2R (PD2R)

Right-angled, used to remove calculus from very narrow inter-root spaces and furcation.

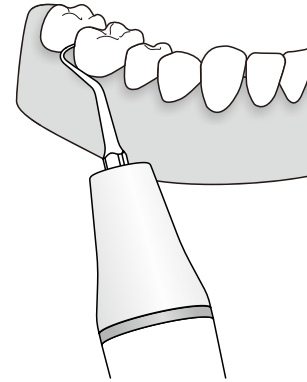
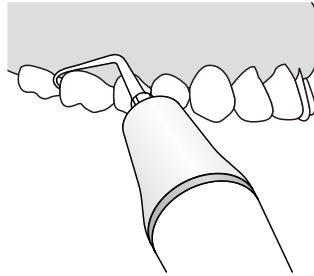
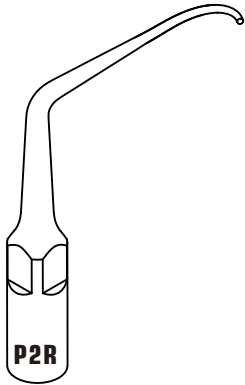

Demo Video

MODE: P
POWER

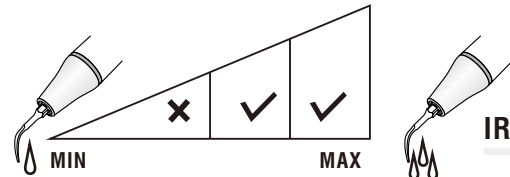
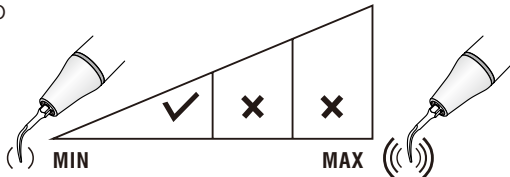

IRRIGATION

P2RD (PD2RD)

Right-angled, diamond-coated (40µm) instrument for root planing.

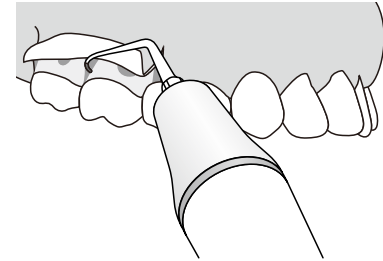
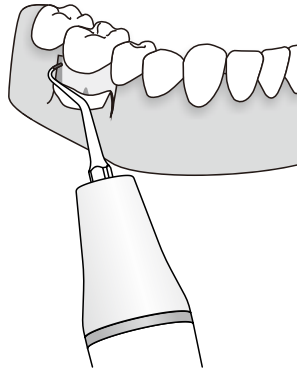
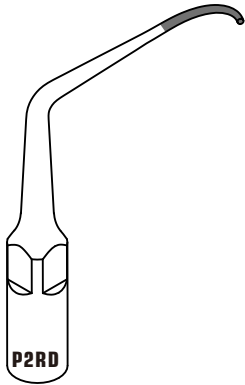

Demo Video

MODE: P
POWER

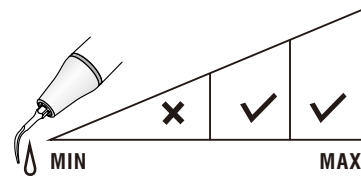
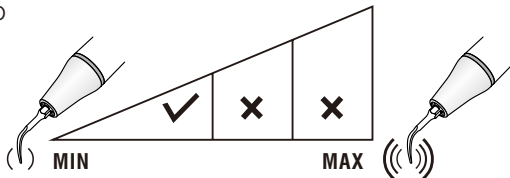

IRRIGATION



P3 (PD3/PS3)

Recommended for cleaning and irrigating of periodontal deep pockets.

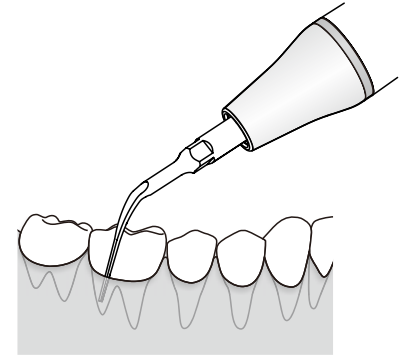
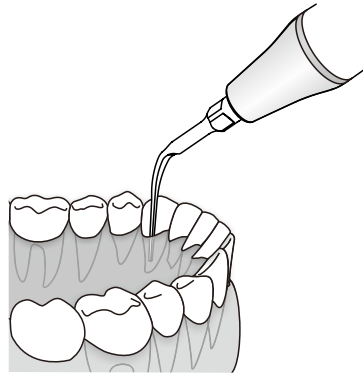
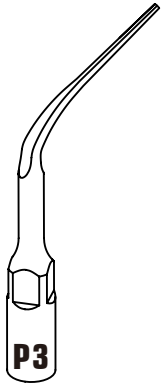

Demo Video

MODE: P
POWER

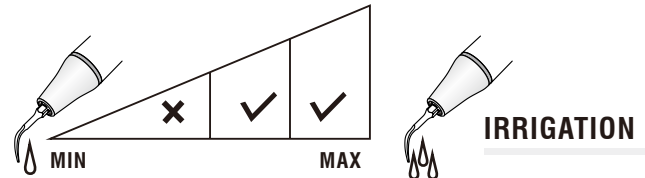
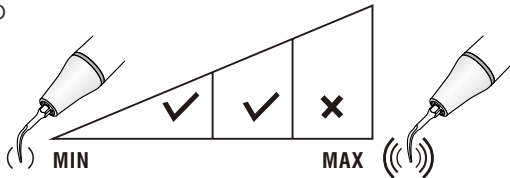

P3L (PD3L)

Left-angled, used for subgingival scaling.

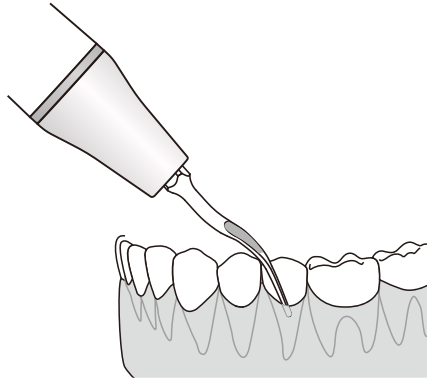

MODE: P
POWER

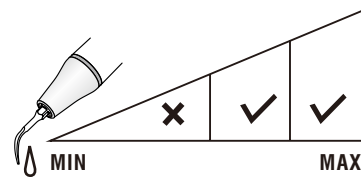
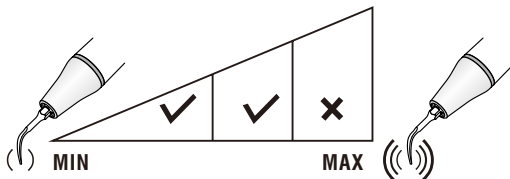

IRRIGATION

P3R (PD3R)

Right-angled, used for subgingival scaling.

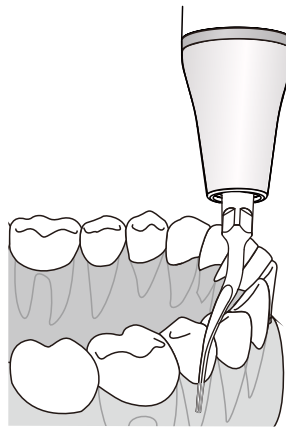

MODE: P
POWER

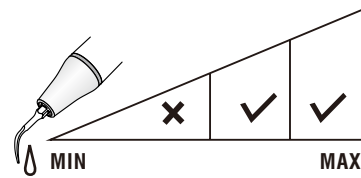
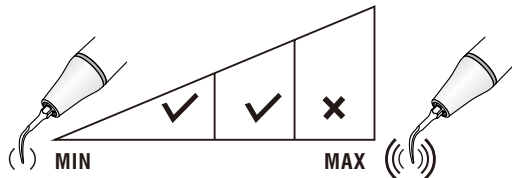

IRRIGATION

P3D(PD3D)

Diamond-coated(40µm) instrument for root planning after the periodontal flap surgery. It's also applied to edge planning of artificial crown and furcation expanding.

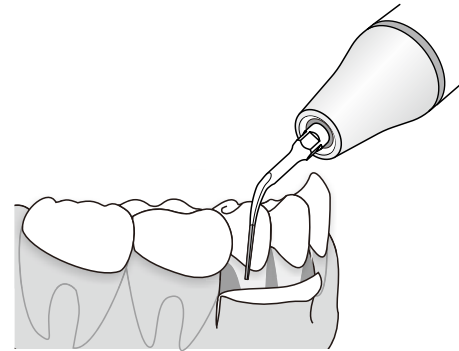
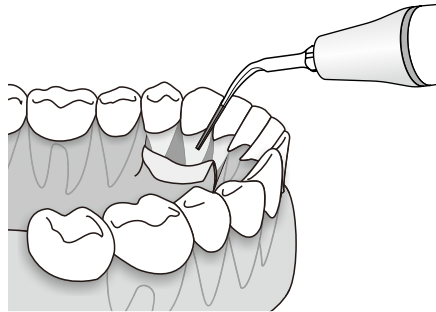
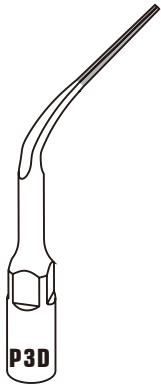

Demo Video

MODE: P
POWER

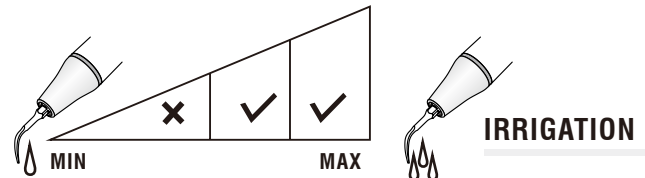
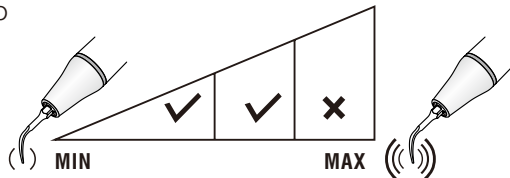

P4 (PD4/PS4)

Recommended for cleaning and irrigating of periodontal shallow pockets.

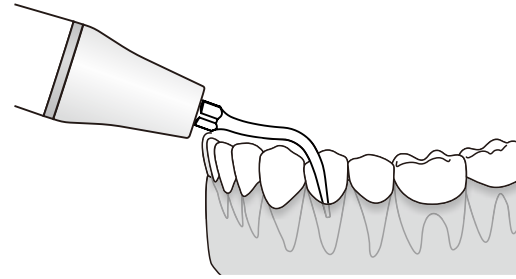
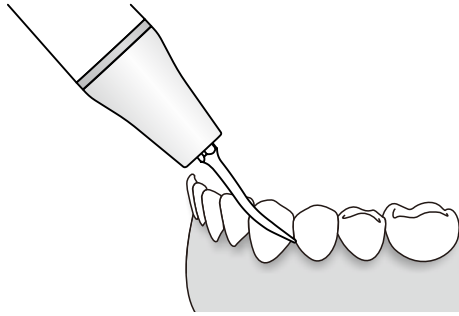
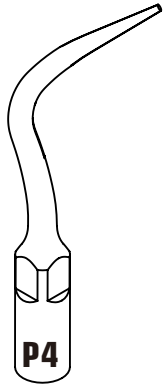

Demo Video

MODE: P
POWER

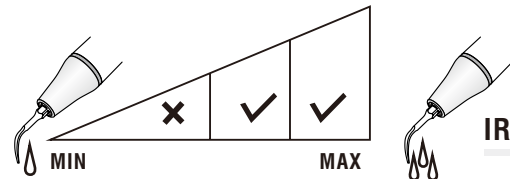
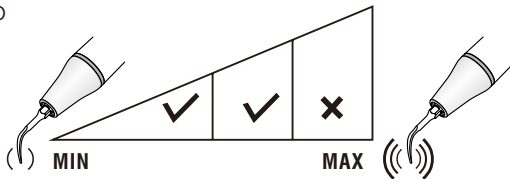

IRRIGATION

P5 (PD5)

For removal of the tartar in the adjacent of teeth and Gingival margin of the neck.

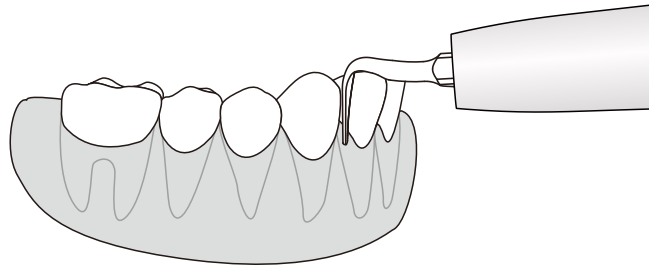

MODE: P
POWER

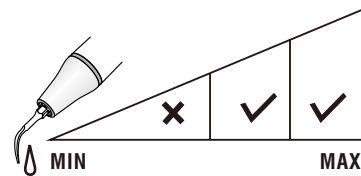
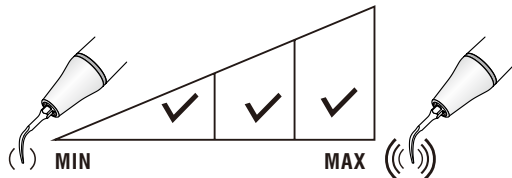

IRRIGATION



P6 (PD6)

Slim and sharp, recommended for cleaning and irrigating of periodontal deep pockets.

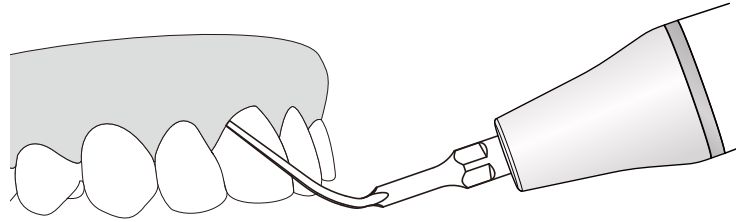
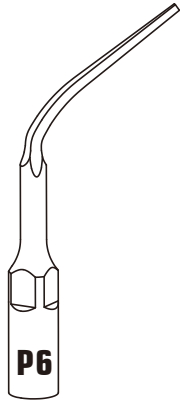

MODE: P
POWER

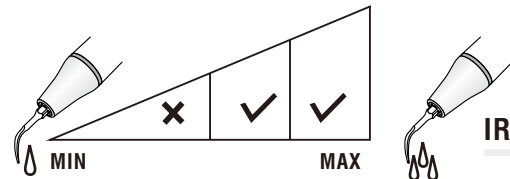
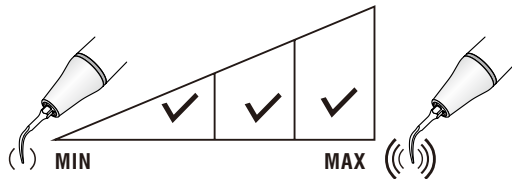

P7 (PD7)

Slim and sharp ,recommended for cleaning and irrigating of subgingival deposits.

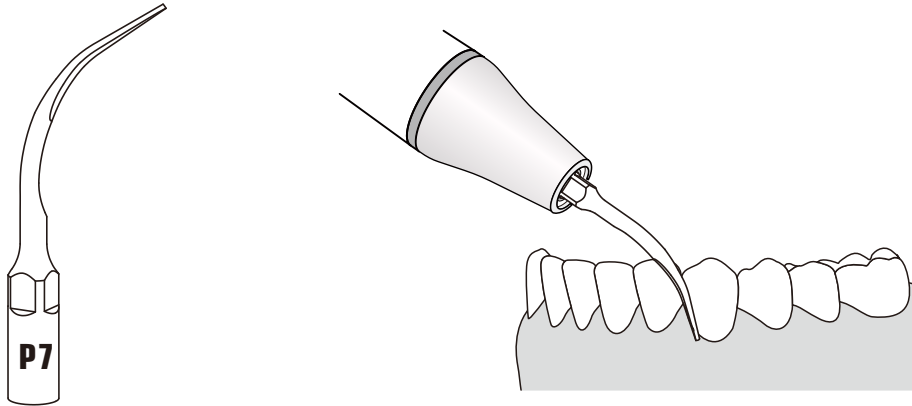

MODE: P
POWER

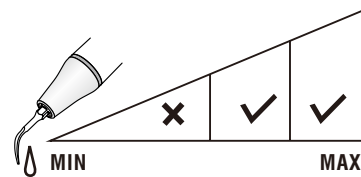
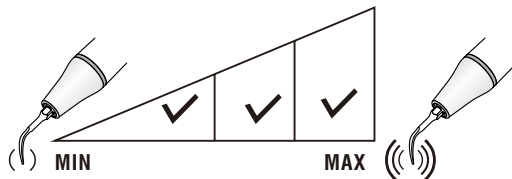

IRRIGATION

P8 (PD8)

Function: used to remove the calculus at shallow periodontal pocket and treat the adjacent tooth surface and ditch area.

Features: The tip is flat and wide, which can be used to clean the teeth surface at subgingival 1/4 and the supragingival part.

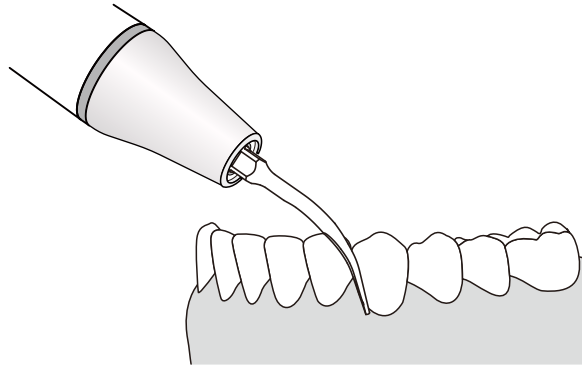
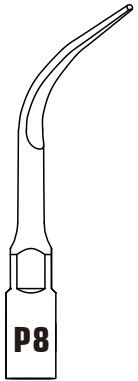

MODE: P
POWER

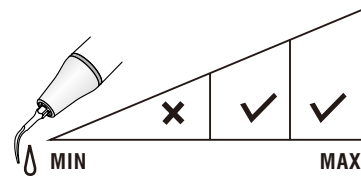
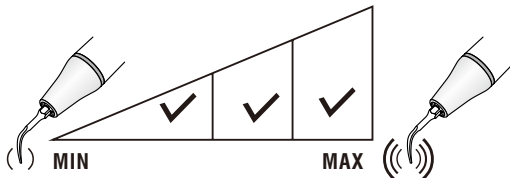

IRRIGATION



P10 (PD10)

For gentle scaling and removal of tartar in the periodontal pocket.

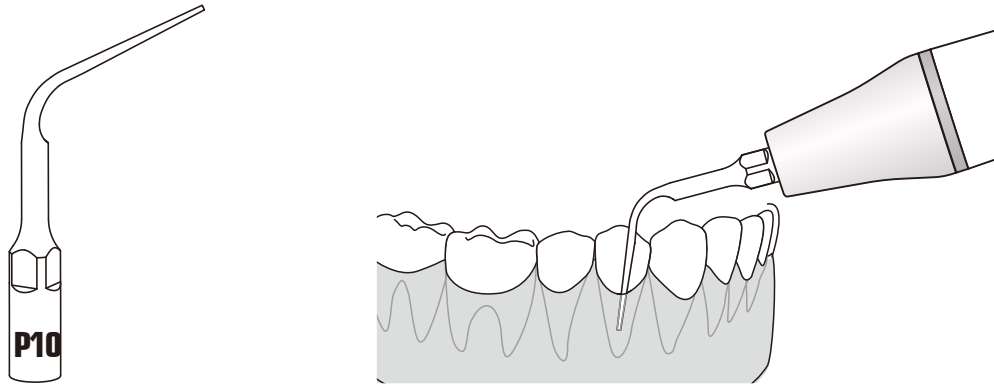

MODE: P
POWER

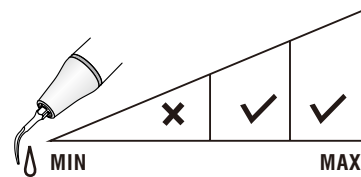
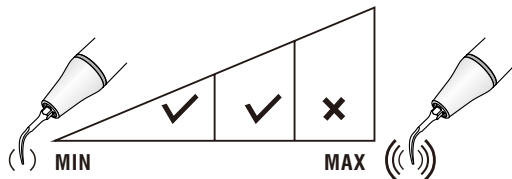

IRRIGATION

P11 (PD11)

For high efficient removal of the stubborn tartar in the subgingival.

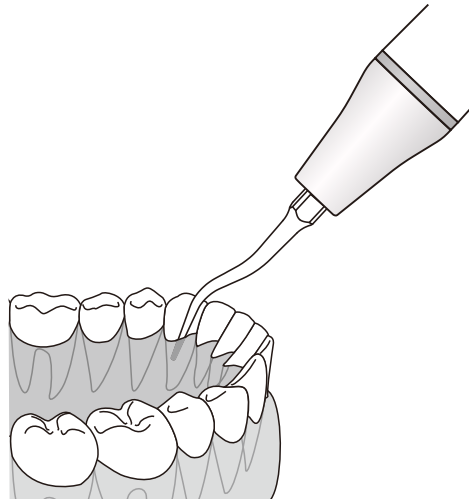

MODE: P
POWER

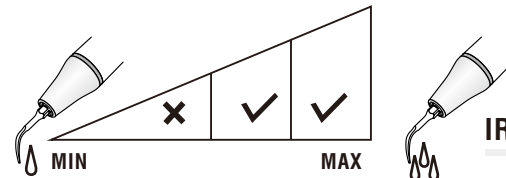
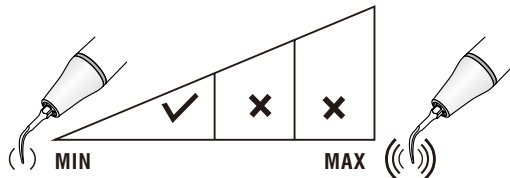

IRRIGATION

P12 (PD12)

With slim blade edge at the end of the tip, for high efficient removal of the stubborn tartar in posterior subgingival.

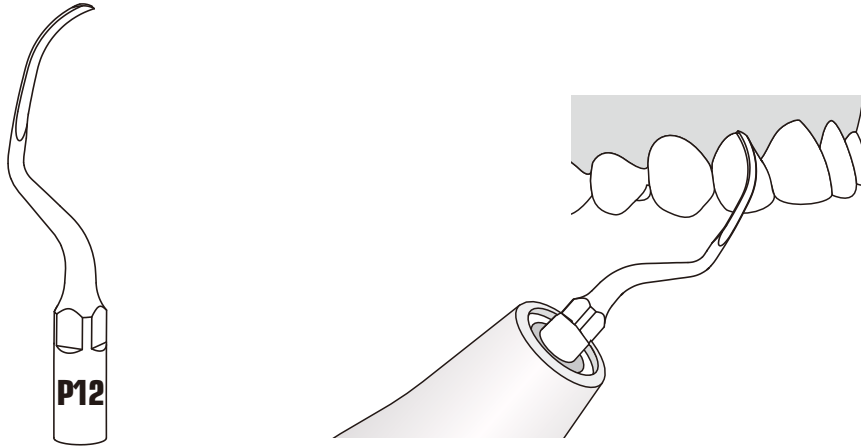

MODE: P
POWER

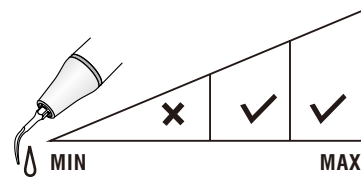
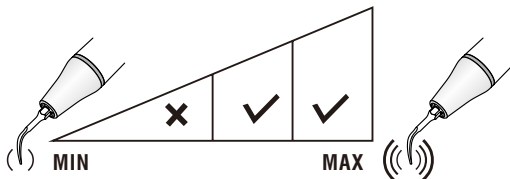

IRRIGATION

P14L(PD14L)

Left curved, with slim blade edge at the end of the tip, for high efficient removal of the stubborn tartar in posterior subgingival.

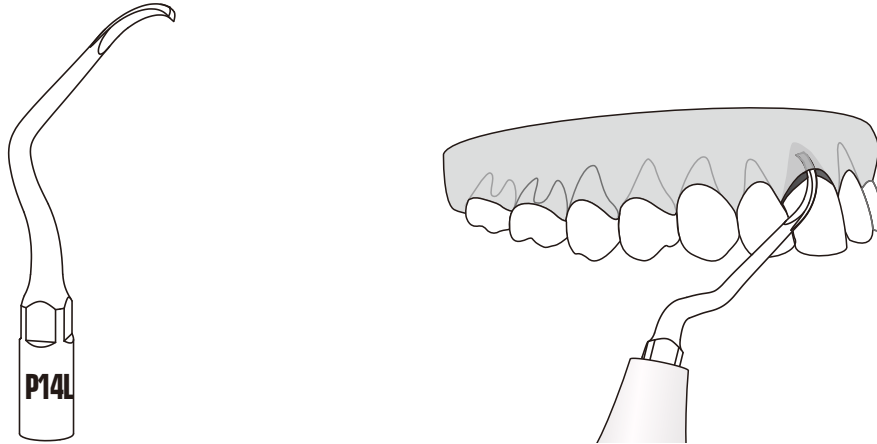

MODE: P
POWER

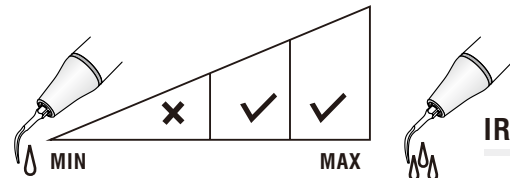
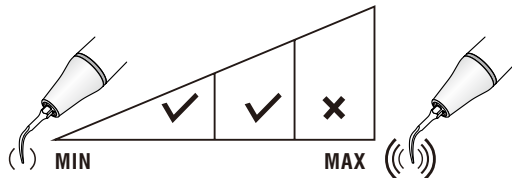

IRRIGATION

P14R(PD14R)

Right curved, with slim blade edge at the end of the tip, for high efficient removal of the stubborn tartar in posterior subgingival.

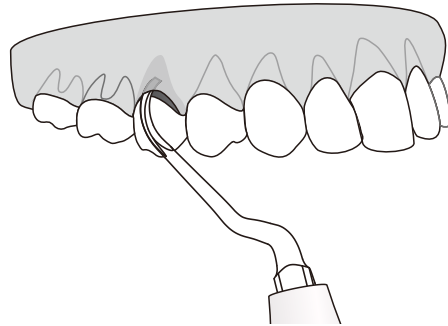
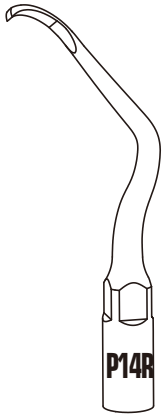

MODE: P
POWER

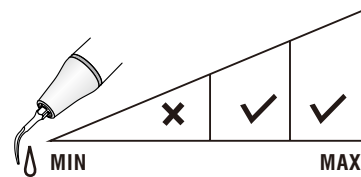
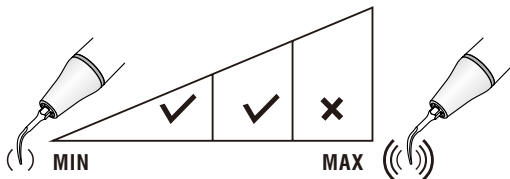

IRRIGATION

P18 (PD18)

For probing the deep periodontal pocket tartar, and subgingival rinse after scaling.

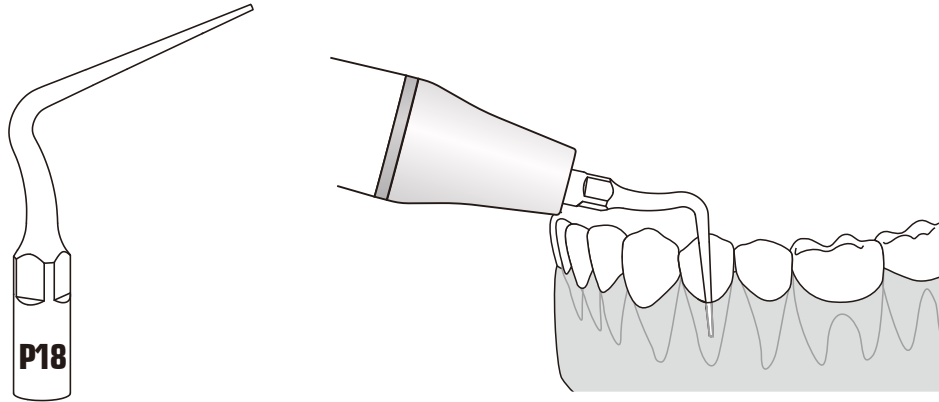

MODE: P
POWER

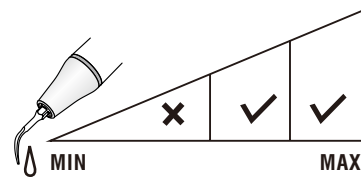
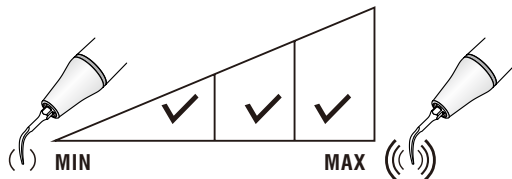

IRRIGATION

P20 (PD20)

For removal of the tartar in the adjacent of teeth, gingival margin of the neck and the tartar within 3mm in the subgingival pocket.

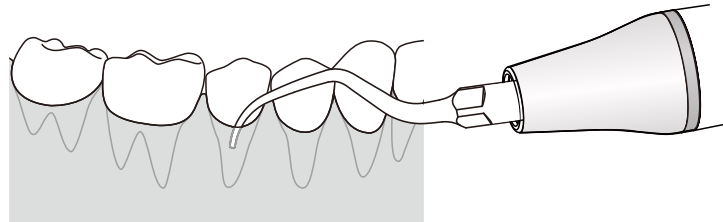

**MODE: P
POWER**

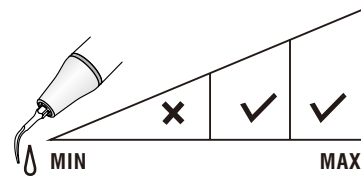
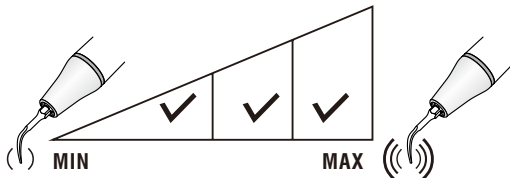

IRRIGATION

P20L (PD20L)

Left curved, for high efficient removal of the stubborn tartar in posterior subgingival.

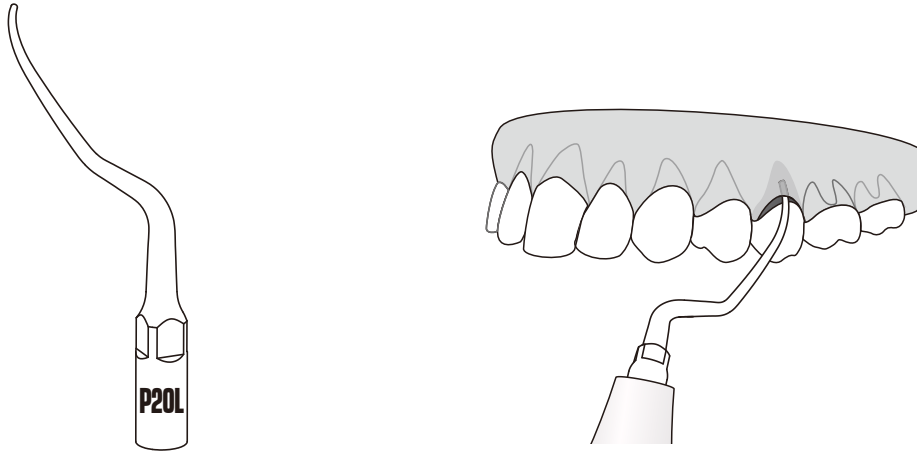

MODE: P
POWER

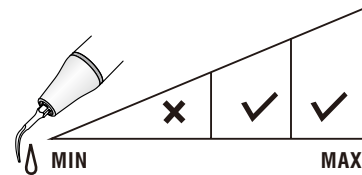
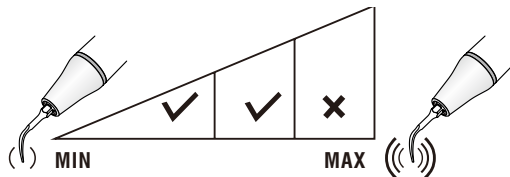

IRRIGATION

P20R (PD20R)

Right curved, for high efficient removal of the stubborn tartar in posterior subgingival.

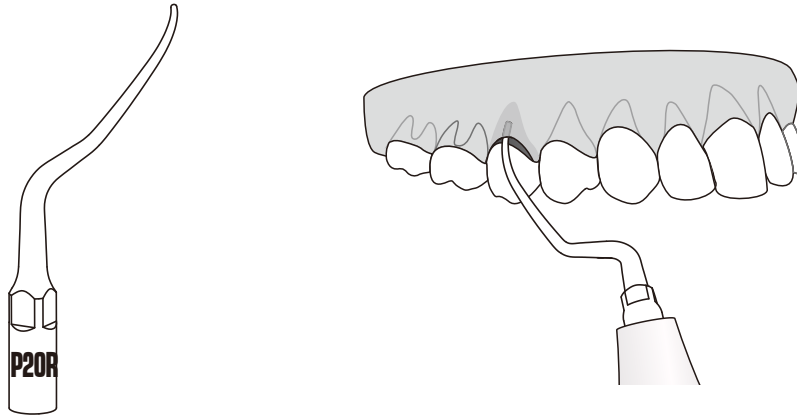

MODE: P
POWER

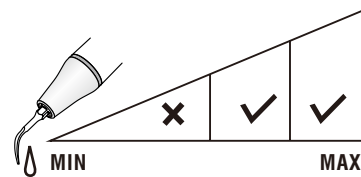
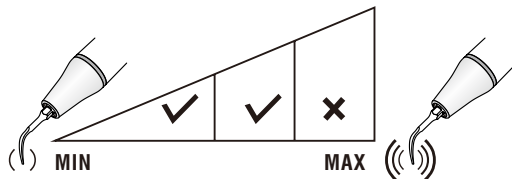

IRRIGATION

P21L(PD21L)

Left curved, for the scaling of root bifurcation and root surface of adjacent of posterior teeth sector.

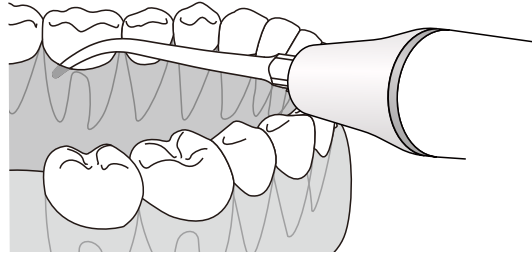

MODE: P
POWER

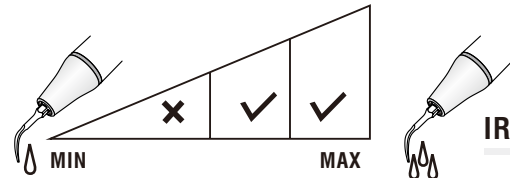
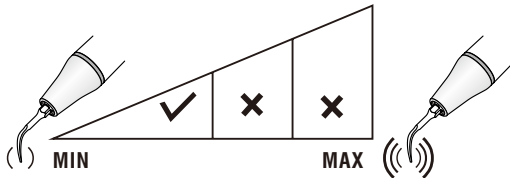

IRRIGATION

P21R(PD21R)

Right curved, for the scaling of root bifurcation and root surface of adjacent of posterior teeth sector.

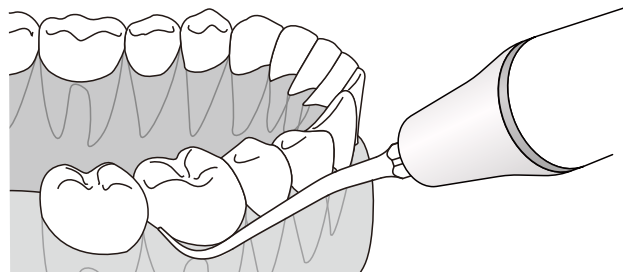

MODE: P
POWER

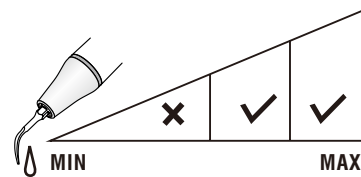
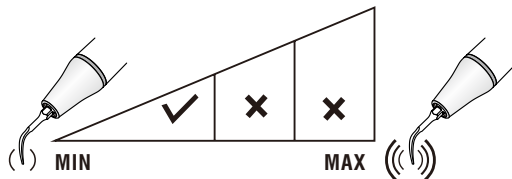

IRRIGATION



P22L (PD22L)

Left curved, the 12mm straight part can assure the complete removal of subgingival tartar and stains.

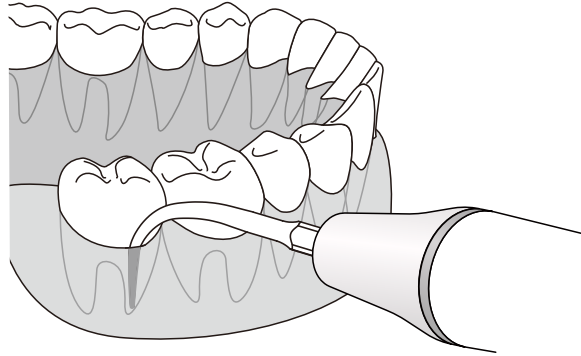
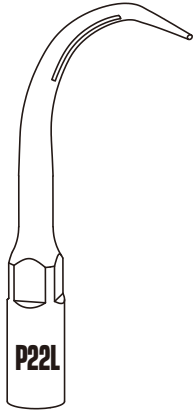

MODE: P
POWER

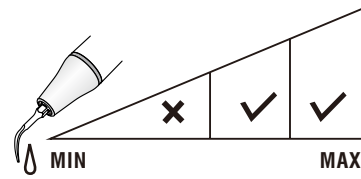
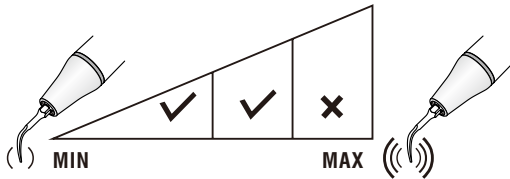

IRRIGATION

P22R (PD22R)

Right curved, the 12mm straight part can assure the complete removal of subgingival tartar and stains.

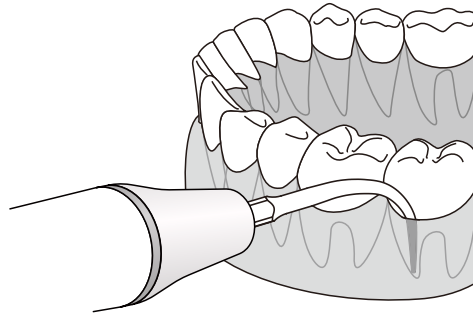
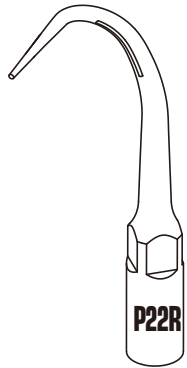

MODE: P
POWER

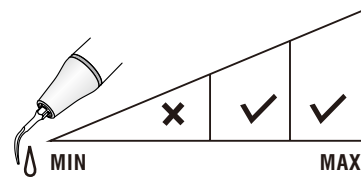
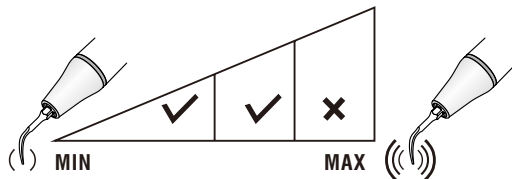

IRRIGATION

P33

Function: Used to remove calculus deep in the periodontal pocket and rinse the periodontal pocket.

Features: The tip is slender and can be used for fine scaling of subgingival root surface.

Use: Used in P mode of PT5. Recommended power level: level 1~8

Note:

(1) The tip is mainly used for treatment in deep periodontal pockets. During use, the power should be set as small as possible and cannot exceed the recommended power level.

(2) The tip has an irrigating function on the periodontal pocket. During operation, the water volume should be set as large as possible.

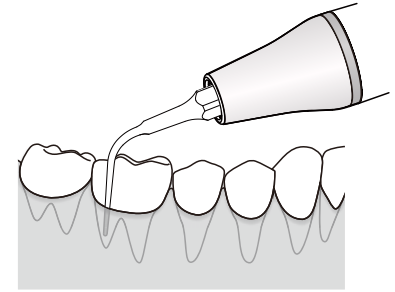
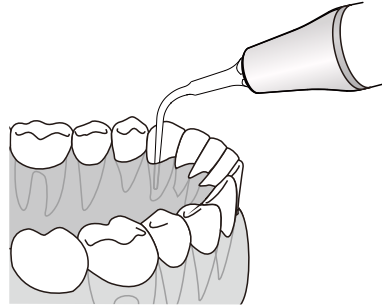
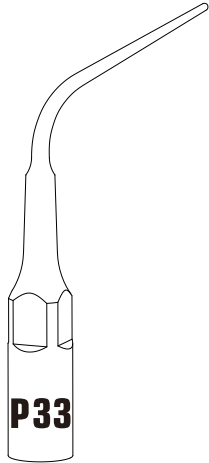

MODE: P
POWER

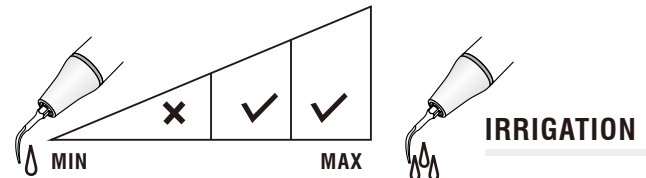
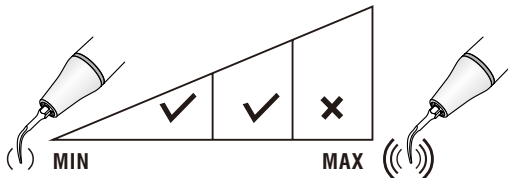

PD40

Function: It can be used as an adapter to hold the implant maintenance tips PD41 and PD42 to clean and maintain the implant.

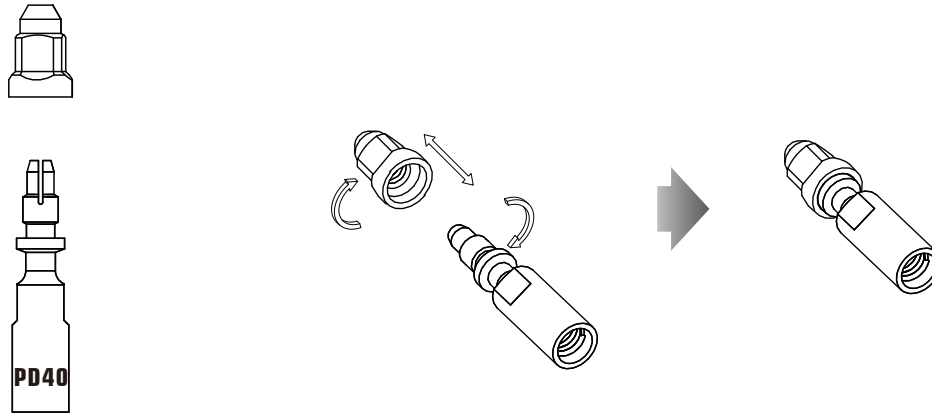

MODE: P
POWER

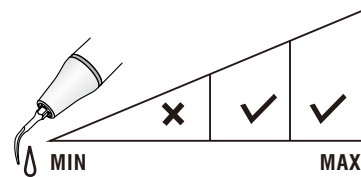
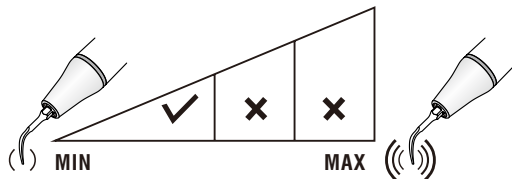

IRRIGATION

PD41

Function: For implant maintenance. It can be installed to PD40 adapter to realize the cleaning and maintenance of implant.

Size: Plastic head is of 15mm length

Features: The tip is of a slender hook shape, making it easier for subgingival cleaning and maintenance.

Use:

a. Used in P mode of D600. Recommended power level: level 1~3. b. Used in P mode of S6. Recommended power level: level 1~6

Note:

(1) The plastic part is made of PEEK material which can be disinfected under high temperature and high pressure, the higher the power, the easier it is to wear;

(2) Avoid the tip stuck in the gap of the tooth during operation to avoid breaking the tip.

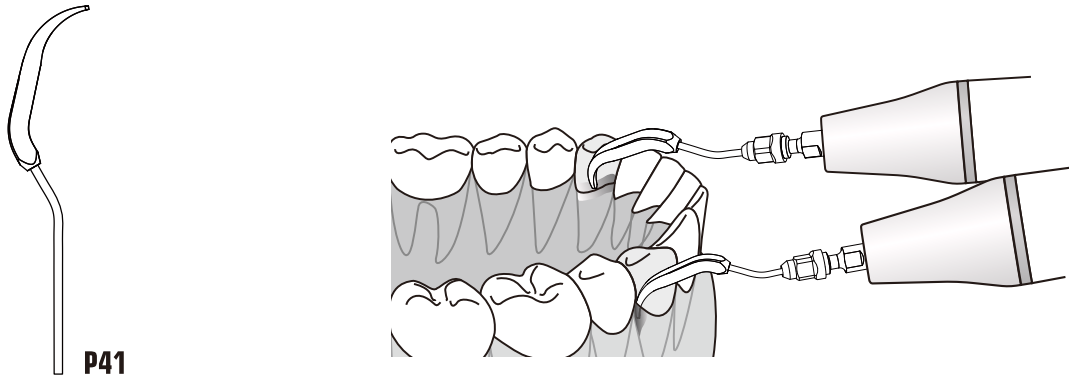

MODE: P
POWER

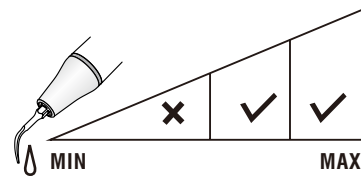
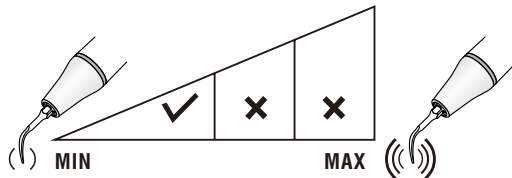

IRRIGATION

PD42

Function: For implant maintenance. It can be installed to PD40 adapter to realize the cleaning and maintenance of implant.

Size: Plastic head is of 19mm length

Features: The tip is of a slender hook shape, making it easier for subgingival cleaning and maintenance.

Use:

a. Used in P mode of d600. Recommended power level: level 1~5. b. Used in P mode of S6. Recommended power level: level 1~9.

Note:

(1) The plastic part is made of PEEK material which can be disinfected under high temperature and high pressure, the higher the power, the easier it is to wear;

(2) Avoid the tip stuck in the gap of the tooth during operation to avoid breaking the tip.

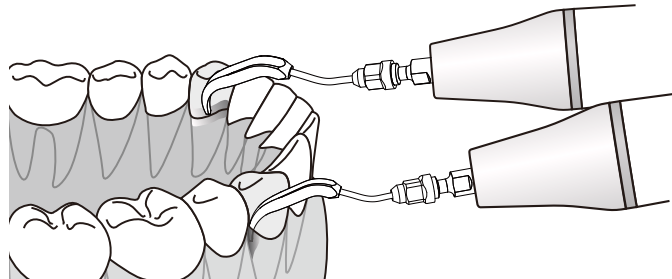
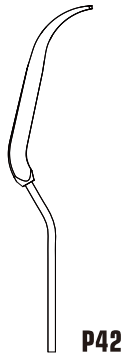

MODE: P
POWER

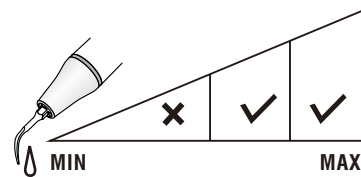
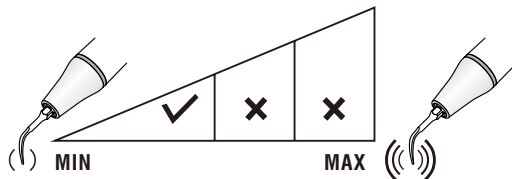

IRRIGATION



E1(ED1/ES1)

120° holder, used to hold the file diameter $\Phi 0.7\text{mm}$ or $\Phi 0.8\text{mm}$.

Recommended for the cleaning and irrigating of the root canal, usually used for the anterior teeth.

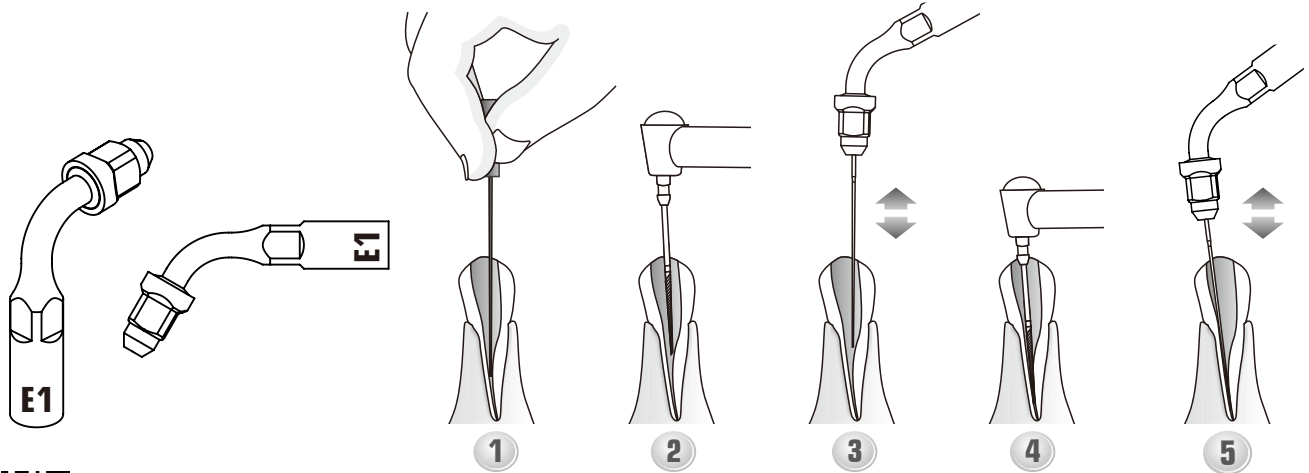

Demo Video

Use only the provided flat wrench to tighten the file holders on the handpiece, as well as for gently tightening the files or instruments in the holder. Do not over tighten.

Do not tighten the holder nut when no file or instrument is installed as this may damage it.

Do not mix-install the holder with $\Phi 0.7\text{mm}$ and $\Phi 0.8\text{mm}$ file, the $\Phi 0.8\text{mm}$ file will not be able to be installed after a $\Phi 0.7\text{mm}$ file installed on the holder. Each Endo file is recommended to be used not more than 10 times.

MODE: E

POWER

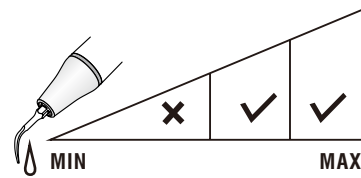
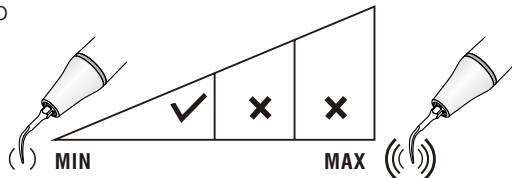

IRRIGATION

E2(ED2/ES2)

95° holder, used to hold the file diameter $\Phi 0.7\text{mm}$ or $\Phi 0.8\text{mm}$.

Recommended for cleaning and irrigation of the root canal, usually used for the molar teeth.

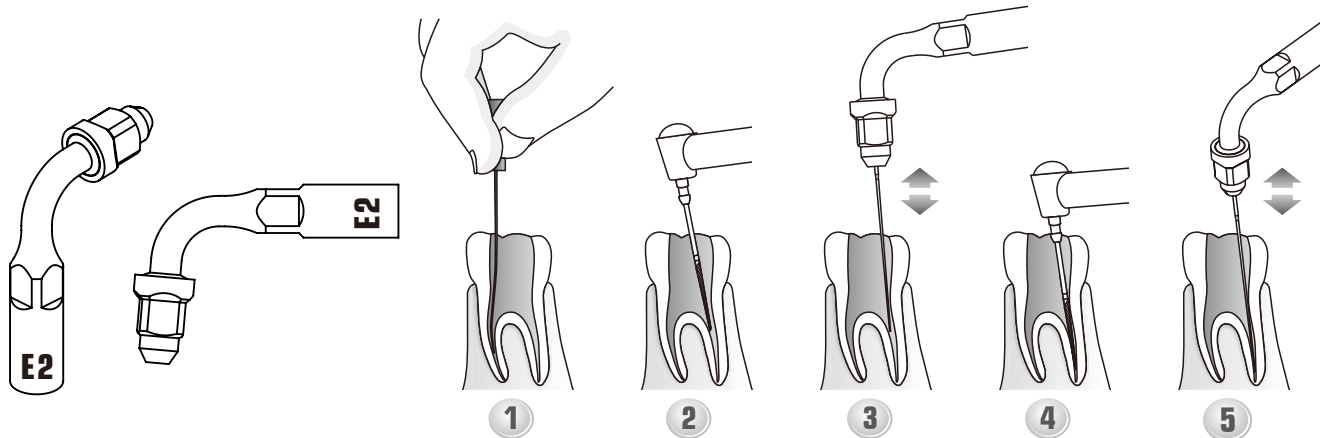

Demo Video

Use only the provided flat wrench to tighten the file holders on the handpiece, as well as for gently tightening the files or instruments in the holder. Do not over tighten.

Do not tighten the holder nut when no file or instrument is installed as this may damage it.

Do not mix-install the holder with $\Phi 0.7\text{mm}$ and $\Phi 0.8\text{mm}$ file, the $\Phi 0.8\text{mm}$ file will not be able to be installed after a $\Phi 0.7\text{mm}$ file installed on the holder. Each Endo file is recommended to be used not more than 10 times.

MODE: E
POWER

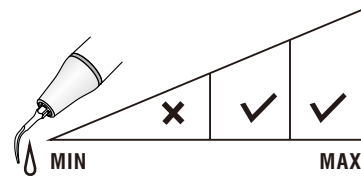
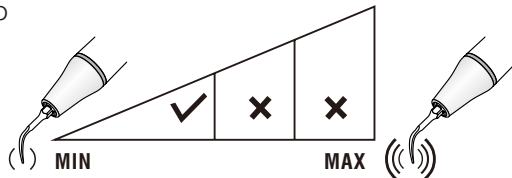

IRRIGATION

E3 (ED3/ES3)

Recommended for melting gutta-percha.

Immerse the instrument in eugenol before inserting it in the canal.

Slightly press the instrument against the cone of gutta-percha and activate the scaler to condense until the canal is filled.

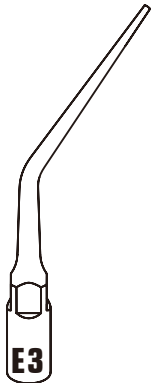

E3



Demo Video

MODE: E

POWER

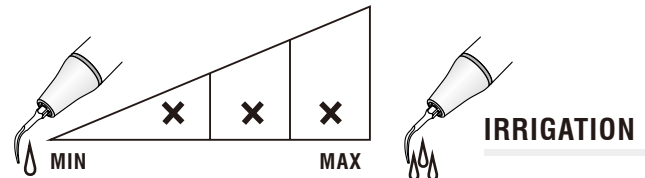
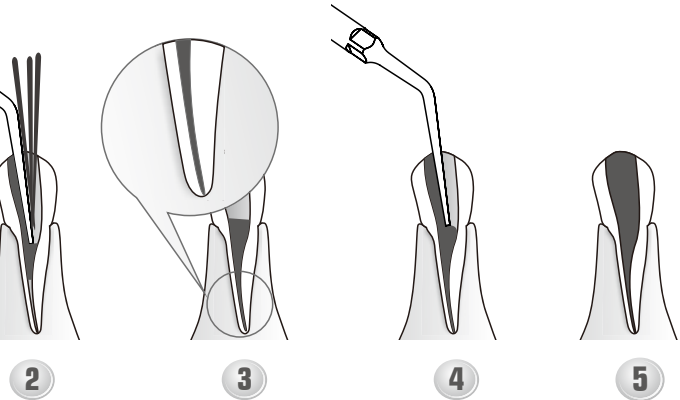
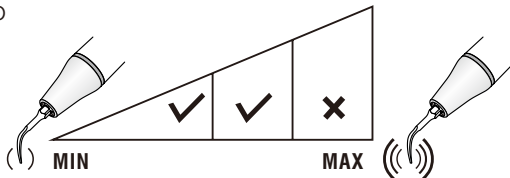

E3D(ED3D/ES3D)

Diamond-coated(40µm) instrument for enlarging the root canal and access to files broken in the root canal.

Don't touch the broken file when enlarging the root canal in case putting it deeper in the canal.

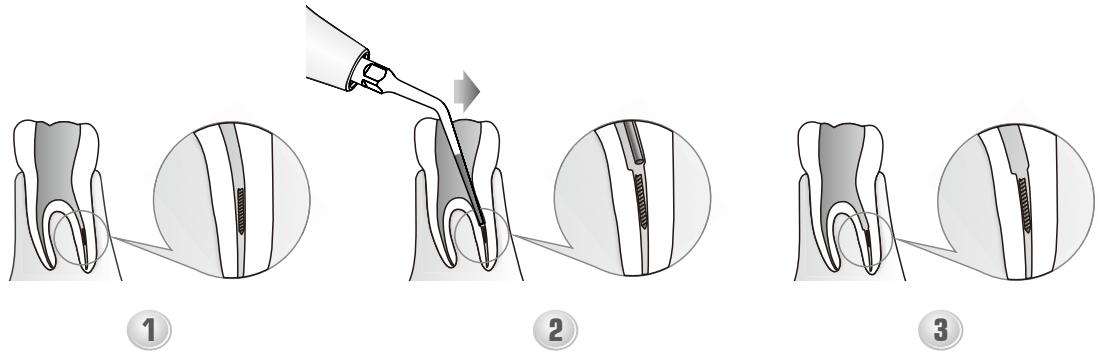
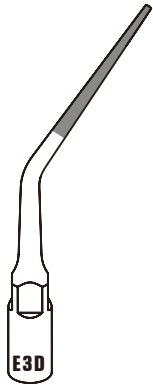

Demo Video

MODE: E
POWER

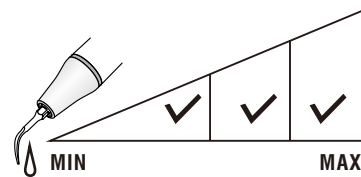
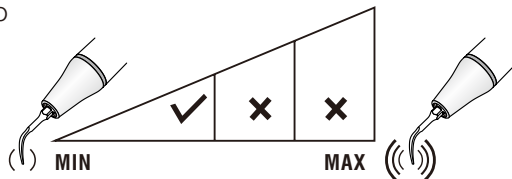

IRRIGATION



E4(ED4/ES4)

Used to remove the root filling obstructions during the root canal retreatment. The length of tip slender part is (22mm).

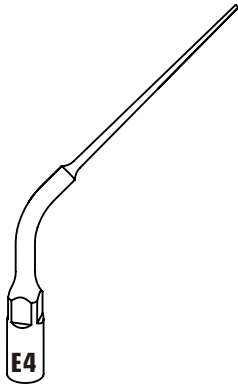

Demo Video

MODE: E
POWER

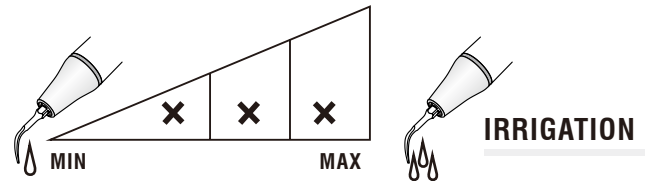
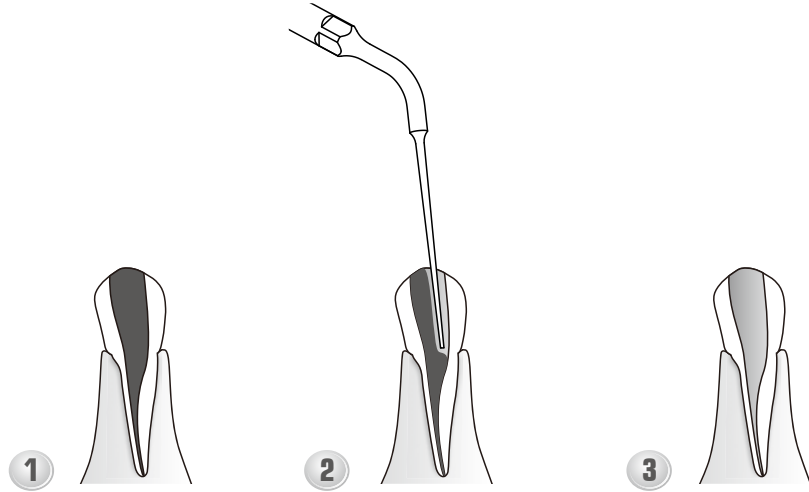
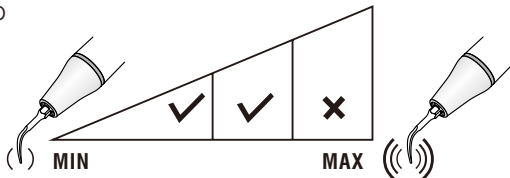

IRRIGATION

E4D(ED4D/ES4D)

Diamond-coated(40µm) instrument for removing the calcification and bad filling material in the root canal during the root canal retreatment. The length of the diamond-coated on tip is (15mm).

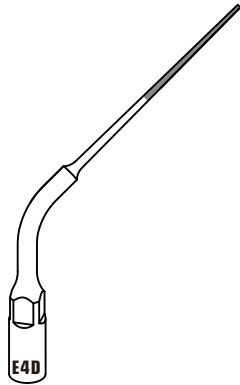

Demo Video

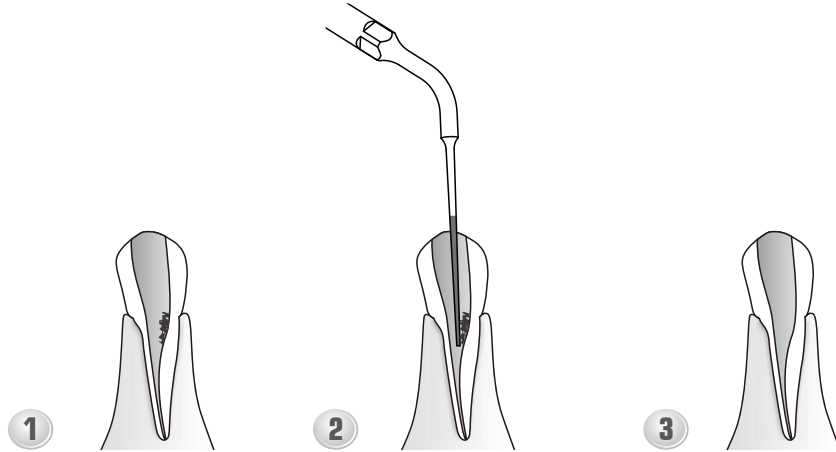

MODE: E
POWER

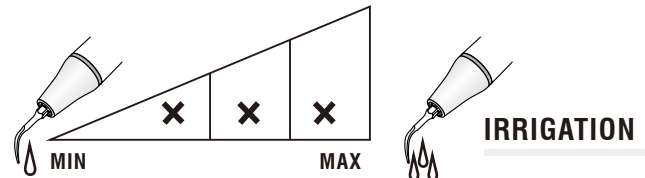
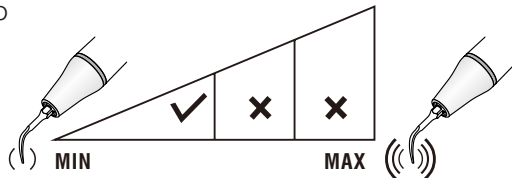

E5 (ED5/ES5)

Used to remove the root filling obstructions during the root canal retreatment. The length of tip slender part is (16mm).

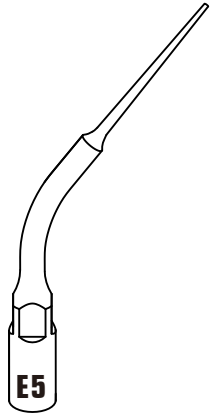

Demo Video

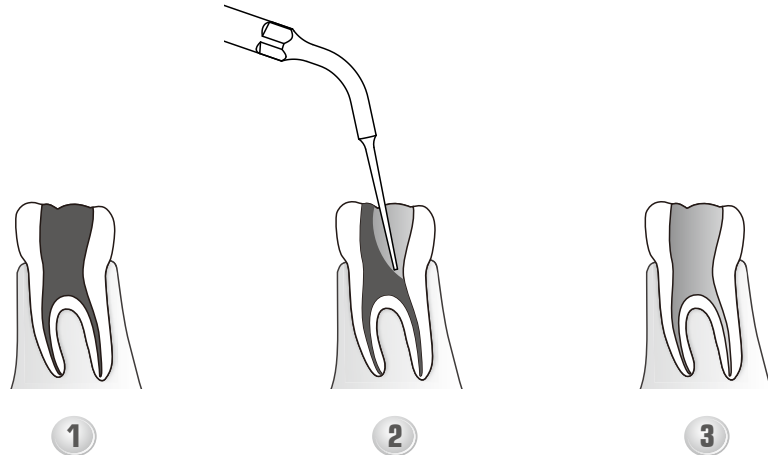

MODE: E
POWER

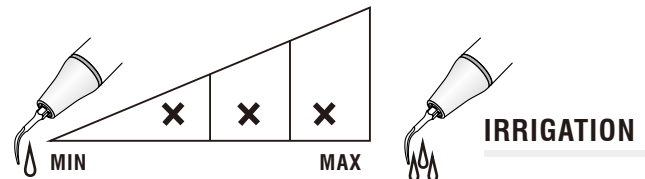
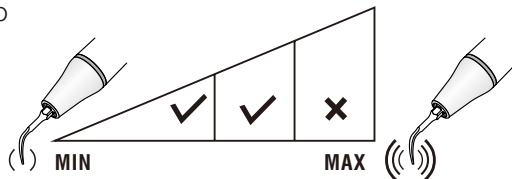

E5D(ED5D/ES5D)

Diamond-coated(40µm) instrument for removing the calcification and bad filling material in the root canal during the root canal retreatment. The length of the diamond-coated on tip is (10mm).

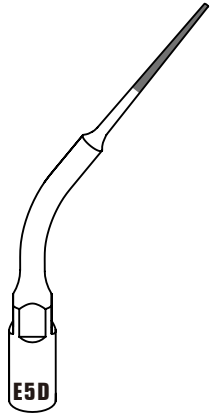

Demo Video

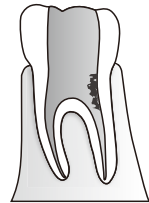

1

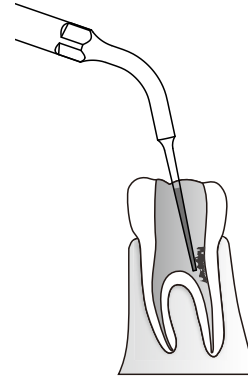

2

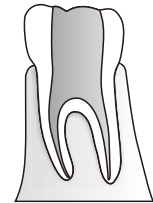

3

MODE: E
POWER

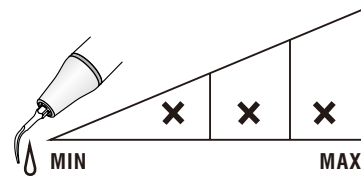
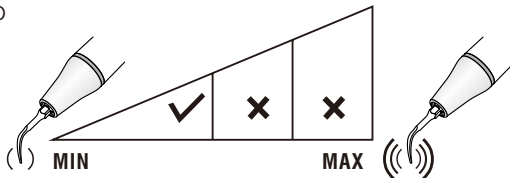

P4D (PD4D/PS4D)

Diamond-coated (40µm) instrument for root canal orientation. It can also be applied to remove the calcifications located at the 1/3 part of root canal. Don't press too much during the treatment to avoid hurting the root canal.

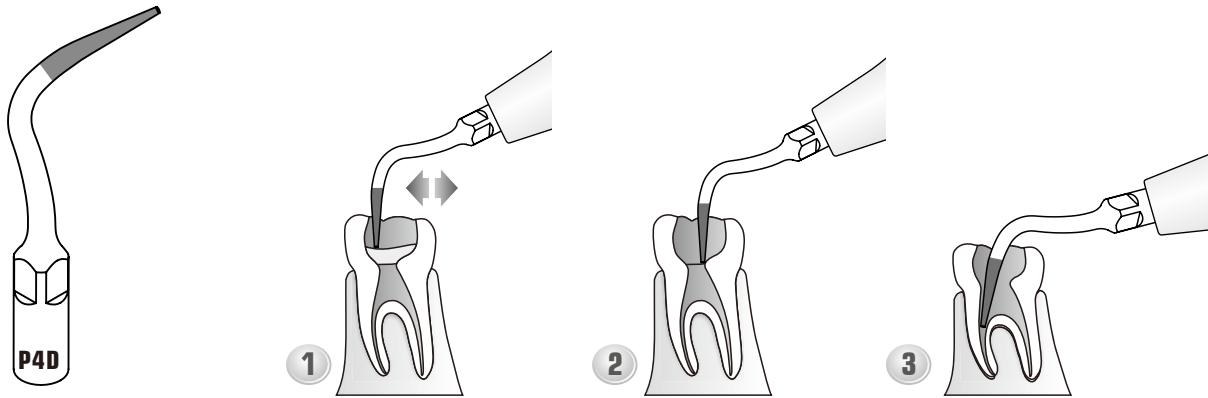

MODE: E
POWER

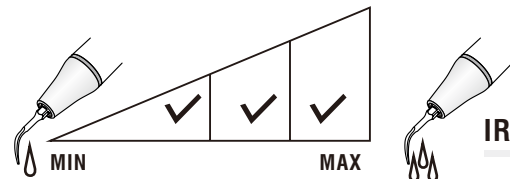
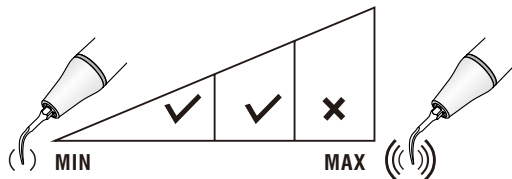

IRRIGATION

E6 (ED6)

Thin and flexible, used for removing foreign body in deep canal.

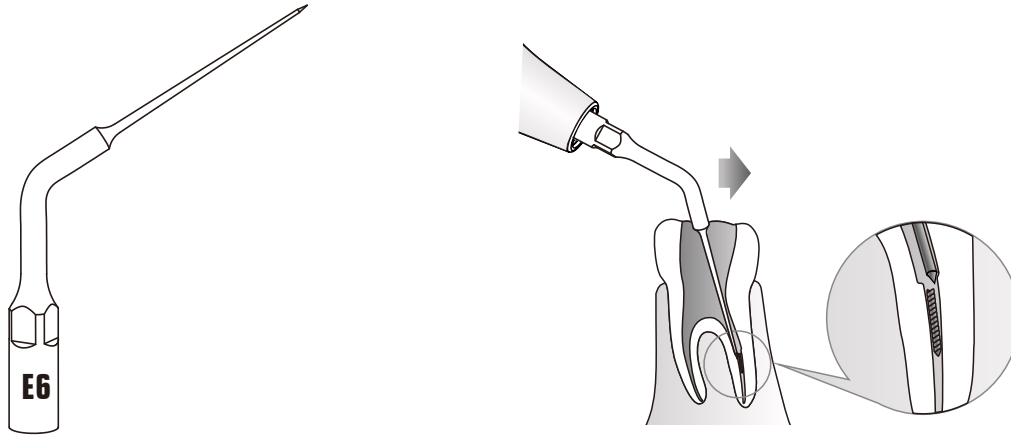

MODE: E
POWER

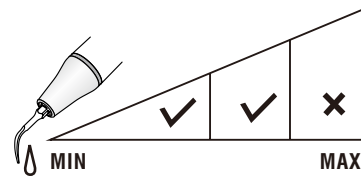
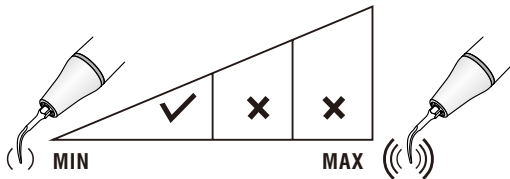

IRRIGATION

E7 (ED7)

Thin and flexible, used for removing foreign body in 1/3 canal.

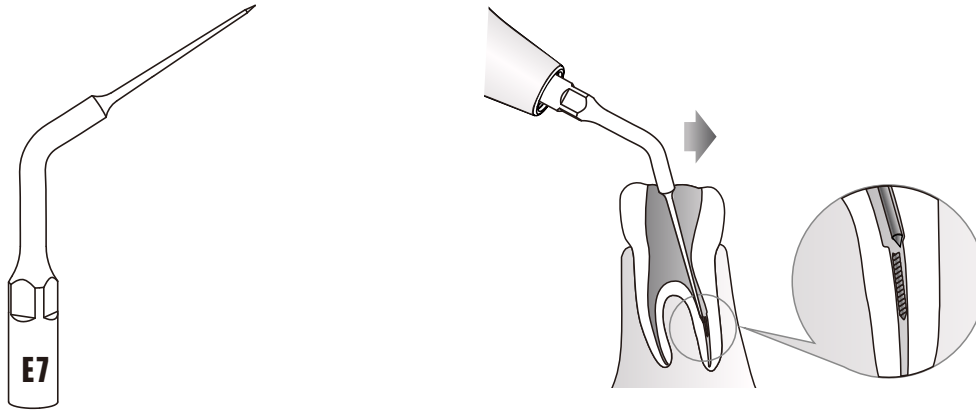

MODE: E
POWER

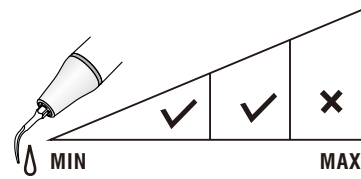
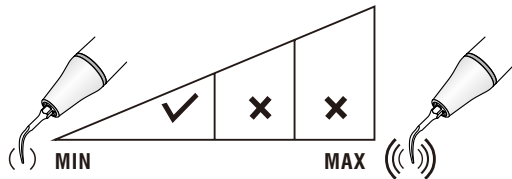

IRRIGATION

E8 (ED8/ES8/EK8)

Recommended for holding different types of dental bur to realize a variety of treatment on teeth. Usually used for the anterior teeth.

Special burs used for dental implant is applicable.

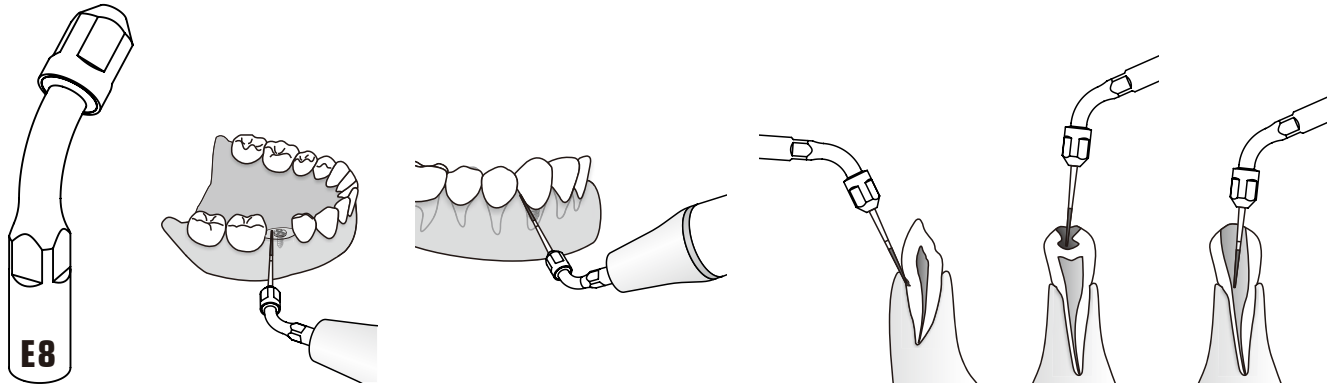

Demo Video

MODE: E
POWER

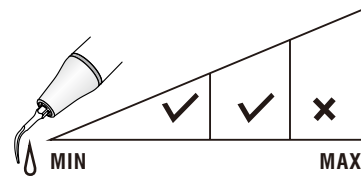
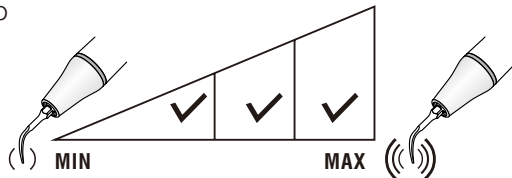

IRRIGATION



E9 (ED9)

Recommended for holding different types of dental bur to realize a variety of treatment on teeth. Usually used for the molar teeth. Special burs used for dental implant is applicable.

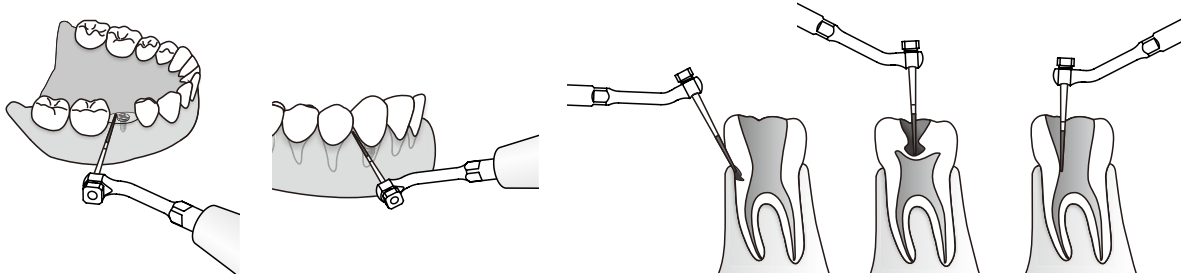
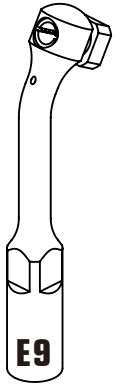

Demo Video

MODE: E
POWER

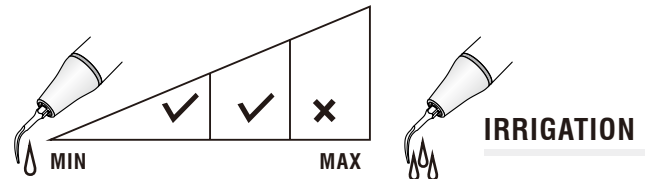
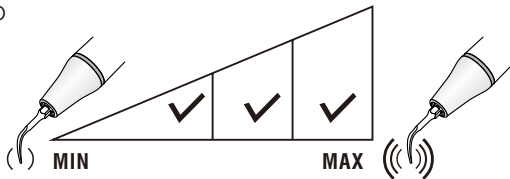

E10(ED10/ES10)

Used to polish the root canal in the retrograde preparation of root canals. The length of tip slender part is (4.5mm).

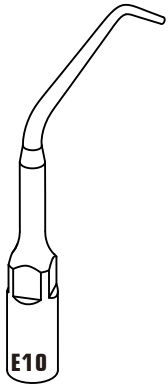

Demo Video

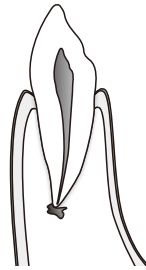

1

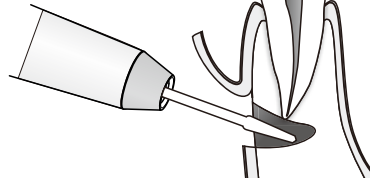

2

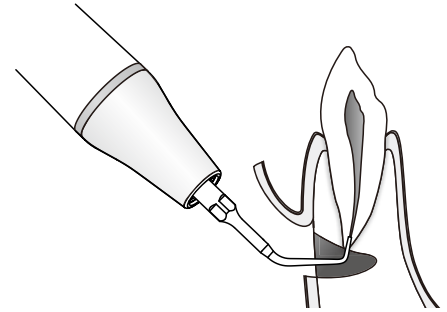

3

MODE: E
POWER

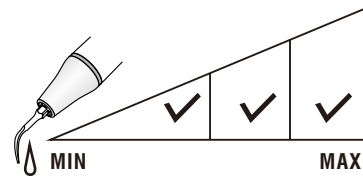
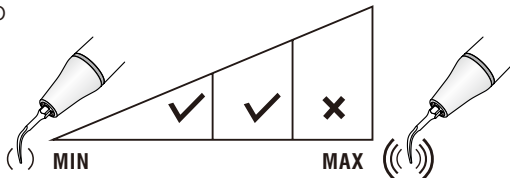

IRRIGATION

E10D(ED10D/ES10D)

Diamond-coated(40µm) instrument for high efficiency root planning in the retrograde preparation of root canals. The length of the diamond-coated on tip is (3.3mm).

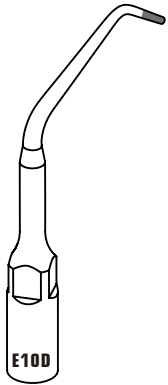

Demo Video

MODE: E
POWER

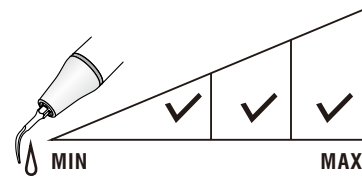
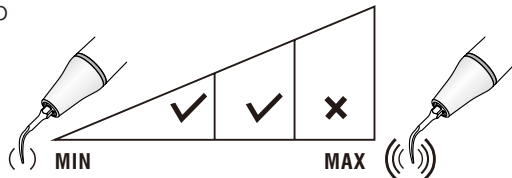

IRRIGATION

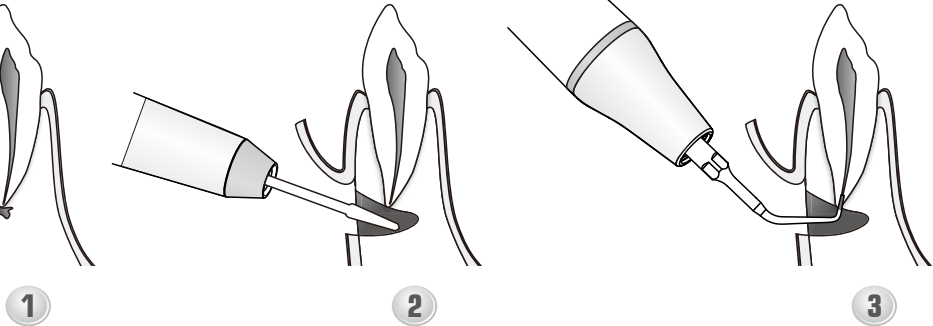

E11(ED11/ES11)

Used to polish the root canal in the retrograde preparation of root canals. The length of tip slender part is (3.5mm).

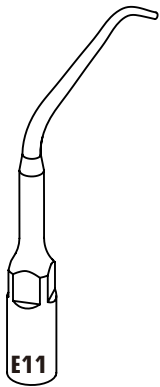

Demo Video

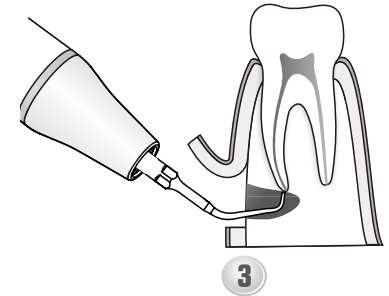
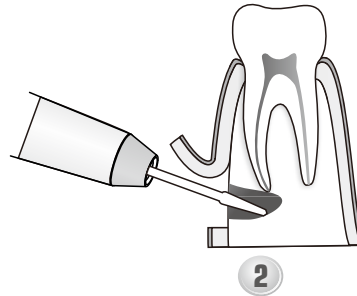
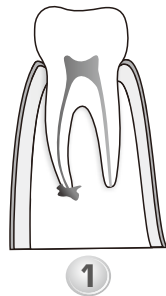

MODE: E
POWER

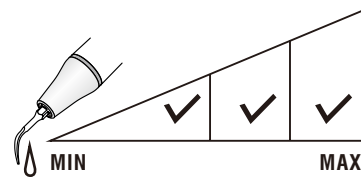
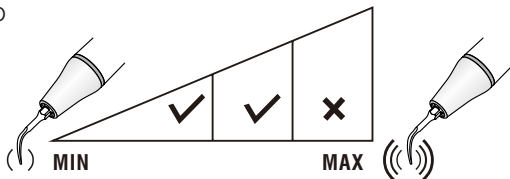

IRRIGATION

E11D(ED11D/ES11D)

Diamond-coated(40µm) instrument for high efficiency root planning in the retrograde preparation of root canals. The length of the diamond-coated on tip is (2.2mm).

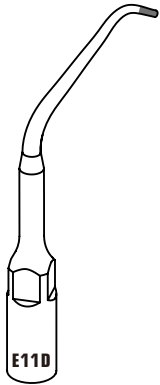

Demo Video

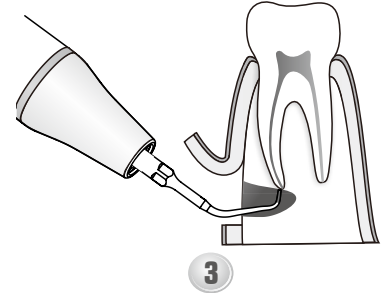
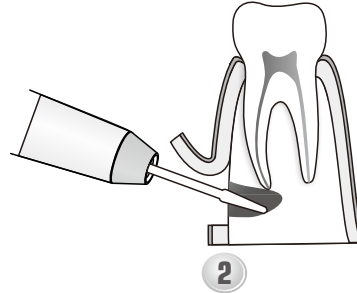
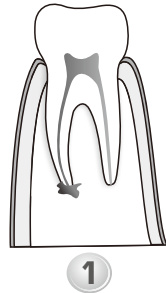

MODE: E
POWER

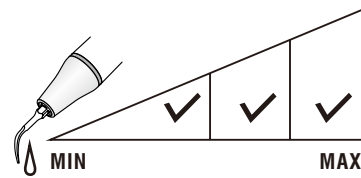
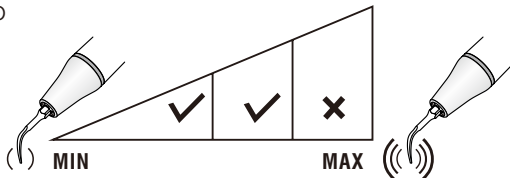

IRRIGATION



E12D(ED12D)

Diamond-coated(90um),used for removing the calcification and bad filling material of pulp cavity,exposing the root canal orifice.

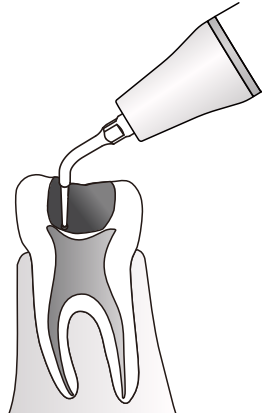
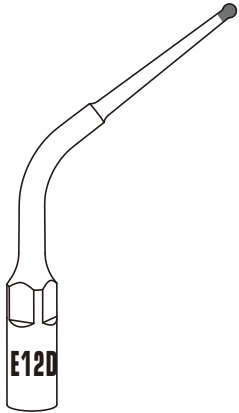

MODE: E
POWER

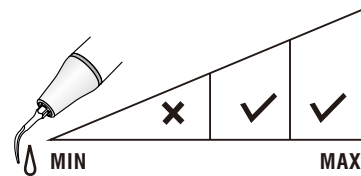
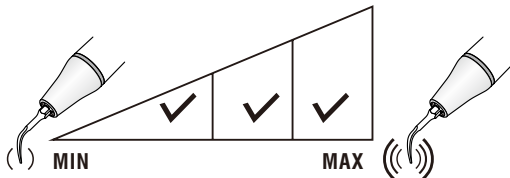

IRRIGATION

E14(ED14/ES14)

Instrument for the removal of broken files inside the root canal. The length of tip slender part is (22mm).

If possible place the patient's head in a position where the root canal is horizontal with a downward inclination. Rotate the tip of the instrument counterclockwise around the broken part until it is picked out from the root canal.

To avoid push the broken file deeper into the root canal, do not use pressure to the instrument in the axial direction.

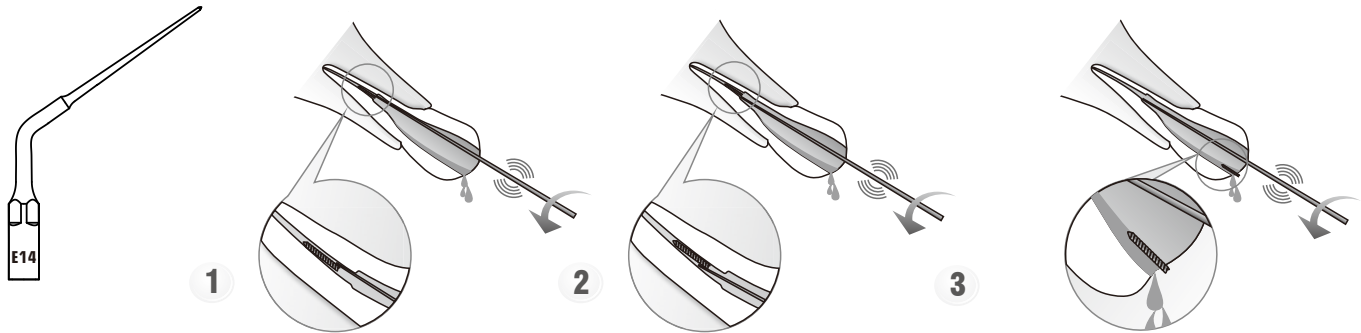

Demo Video

MODE: E

POWER

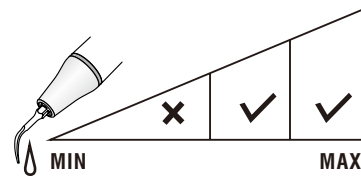
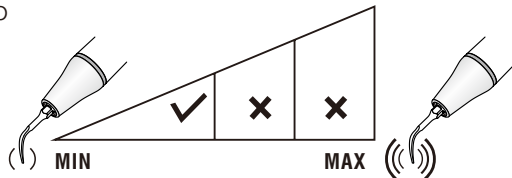

IRRIGATION

E14D(ED14D)

Diamond-coated(40um) instrument for removing the calcification and bad filling material in the root canal during the root canal retreatment. The length of the diamond-coated on tip is (15mm). With irrigation.

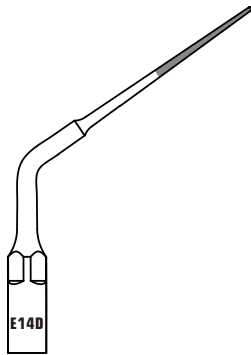

1

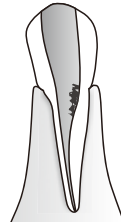

2

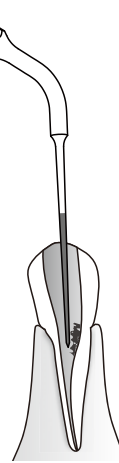

3

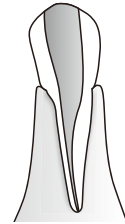

Demo Video

MODE: E
POWER

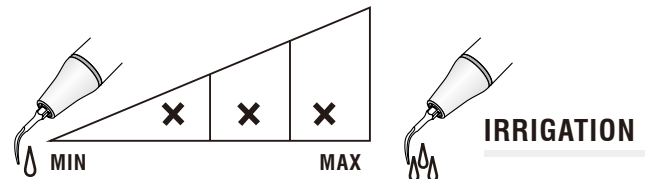
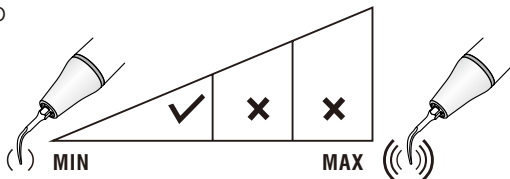

E15(ED15/ES15)

Instrument for the removal of broken files inside the root canal. The length of tip slender part is (16mm).

If possible place the patient's head in a position where the root canal is horizontal with a downward inclination. Rotate the tip of the instrument counterclockwise around the broken part until it is picked out from the root canal.

To avoid push the broken file deeper into the root canal, do not use pressure to the instrument in the axial direction.

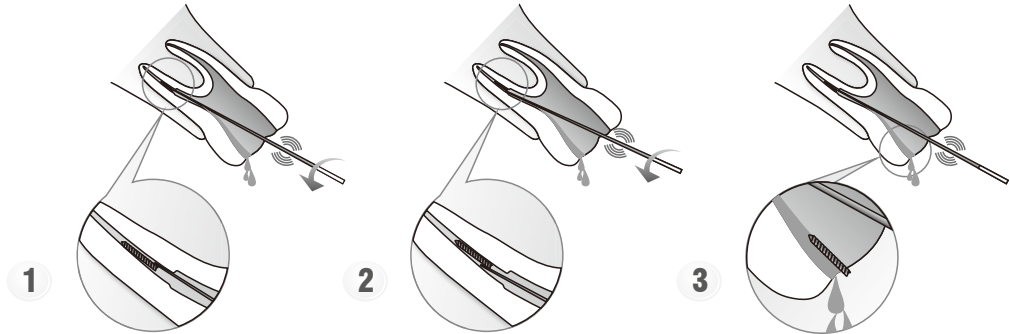
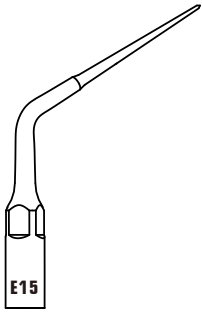

Demo Video

MODE: E
POWER

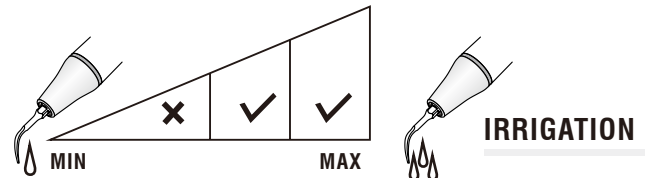
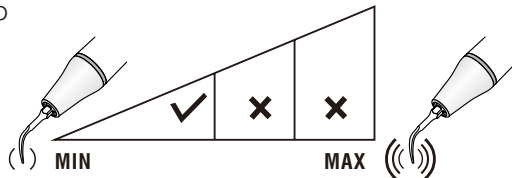

IRRIGATION

E15D(ED15D)

Diamond-coated(40um) instrument for removing the calcification and bad filling material in the root canal during the root canal retreatment. The length of the diamond-coated on tip is (10mm). With irrigation.

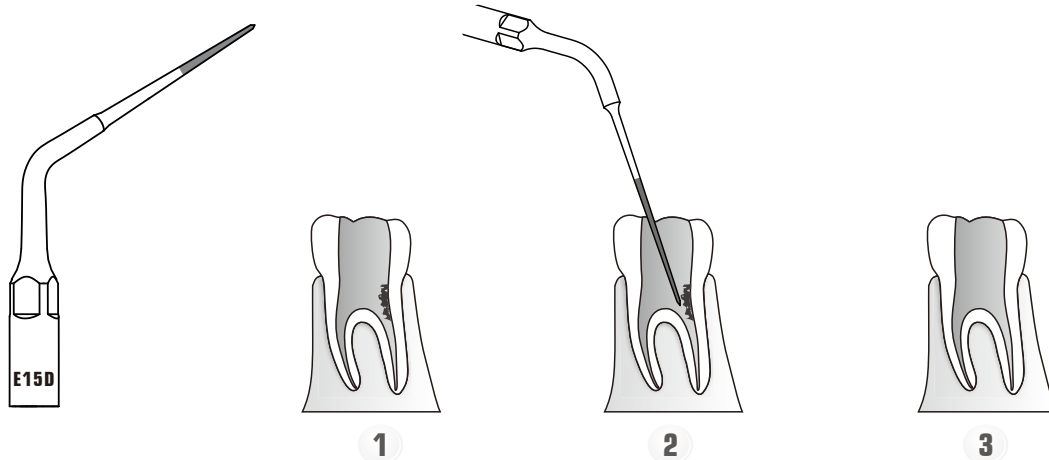

Demo Video

MODE: E
POWER

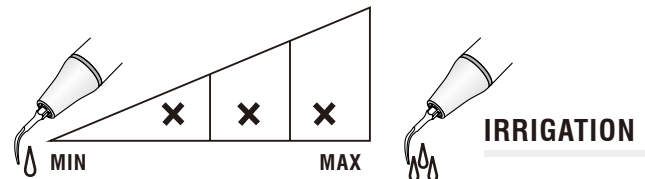
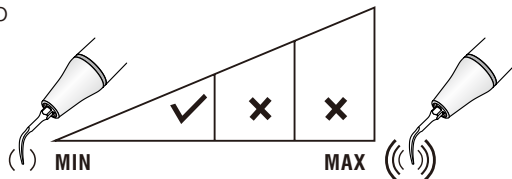

IRRIGATION

ED17

Function: Used for root canal detection, pulp chamber cleaning, and orifice opening.

Features: The tip has 15 micro-washers, and it is of good cutting performance.

Back and forth motion of tip brings more efficient operation.

In the case of waterless operation, select the mode of "Work for 5~10 seconds and then stop for 2 seconds", and open water every 60 seconds for cooling and rinsing.

Note:

(1) Due to the strong cutting performance of the tip, in order to prevent the penetration of the medullary cavity, it is recommended to use with a root canal microscope.

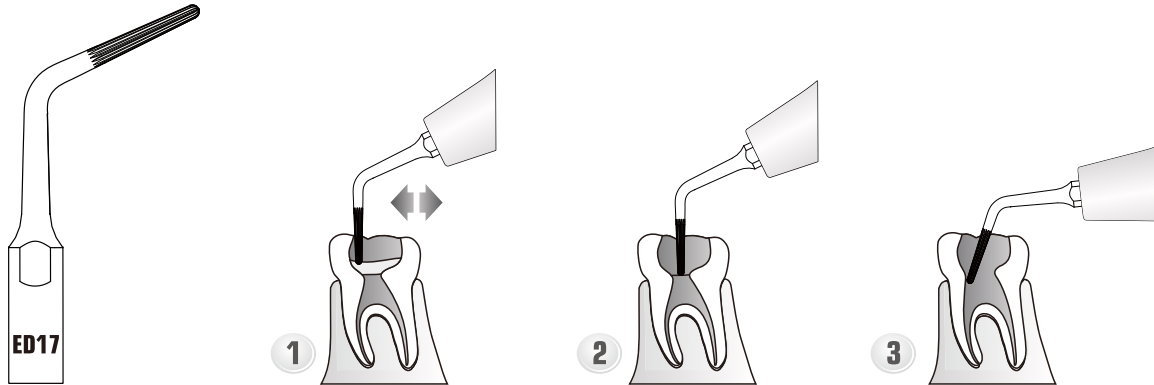

MODE: E
POWER

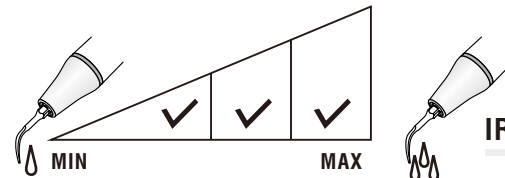
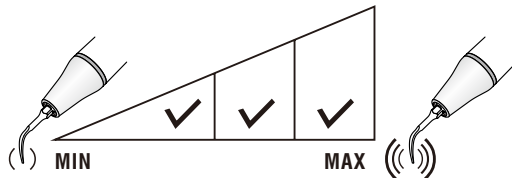

IRRIGATION

ED18

Function: Used to determine the position of the root canal, remove the dentin, calcification and loose crown at the 1/3 crown of the root canal.

Features: The tip has 12 micro-washers, and it is of good cutting performance.

Back and forth motion of tip brings more efficient operation.

In the case of waterless operation, select the mode of “Work for 5~10 seconds and then stop for 2 seconds”, and open water every 60 seconds for cooling and rinsing.

Note:

(1) Due to the strong cutting performance of the tip, in order to prevent the penetration of the medullary cavity, it is recommended to use with a root canal microscope.

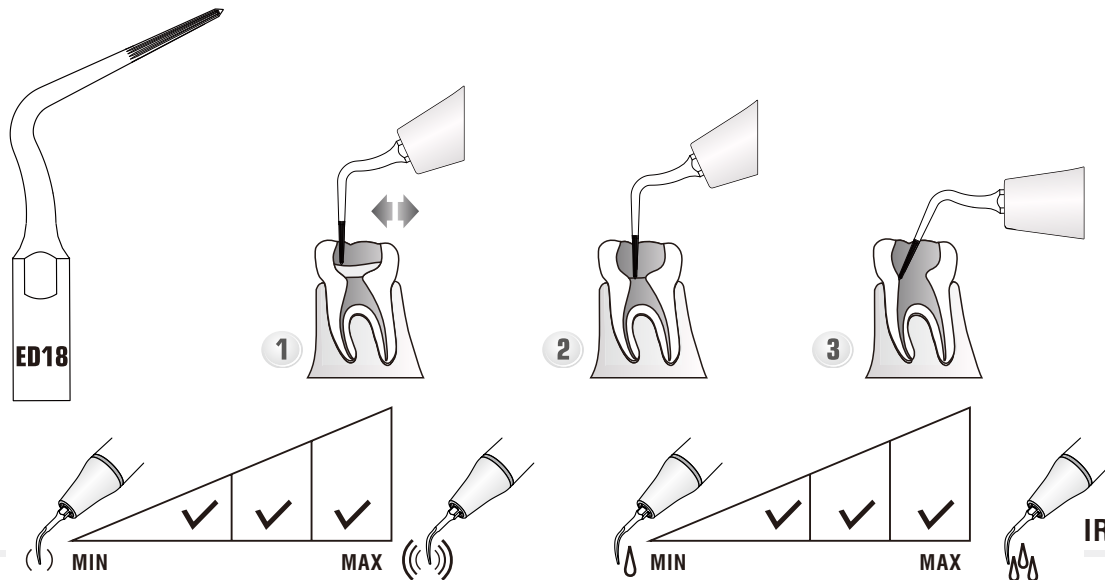

E60(ED60)

Features: Minimally invasive irrigation; the working part is spiral but not sharp, with basically no cutting ability, effectively avoiding the root canal shape from being destroyed, bringing efficient and safe operation.

Irrigating operation: Put the irrigating tip into the root canal, try to keep the tip unstressed, start the device for 20 seconds and then stop to clean the root canal. Generally, a root canal needs to be irrigated 3×20 seconds.

Recommended service life: 30 ~ 50 root canals

Note: (1) In order to ensure the service life of the tip, it is recommended to use it according to the recommended method: first perform the external debugging, start the foot pedal under power level 1, ensure the water output is normal, and adjust the power within the power level limit (level 1~6) according to individual need to ensure that the water output can reach the tip end (the water can reach the tip end through adjusting water volume). After all the above steps, start root canal irrigation.

(2) During irrigation, in order to avoid instrument fracture, please prevent tip from getting stuck and vibrating in root canal.

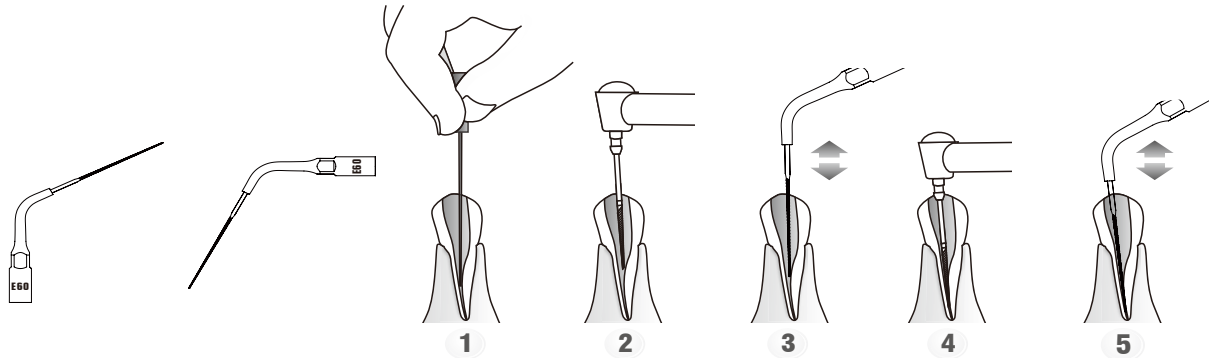

MODE: E
POWER

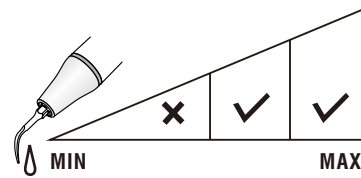
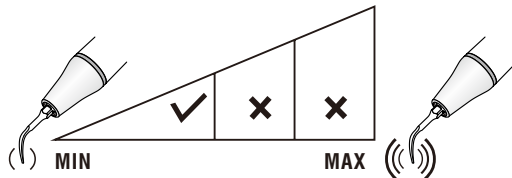

IRRIGATION

E62(ED62)

Function: Used for irrigation of root canal after root canal preparation.

Dimensions: $\varnothing 0.3\text{mm}$; taper 0%. Working part length: 16mm

Features: Minimally invasive irrigation; the surface of working part is smooth, with cutting ability, effectively avoiding the root canal shape from being destroyed, bringing safer operation.

Irrigating operation: Put the irrigating tip into the root canal, try to keep the needle unstressed, start the device for 20 seconds and then stop to clean the root canal. Generally, a root canal needs to be irrigated 3×20 seconds.

Recommended service life: 30 ~ 50 root canals

Note: (1) In order to ensure the service life of the tip, it is recommended to use it according to the recommended method: first perform the external debugging, start the foot pedal under power level 1, ensure the water output is normal, and adjust the power within the power level limit (level 1~3) according to individual need to ensure that the water output can reach the tip end (the water can reach the tip end through adjusting water volume). After all the above steps, start root canal irrigation.

(2) During irrigation, in order to avoid instrument fracture, please prevent tip from getting stuck and vibrating in root canal.

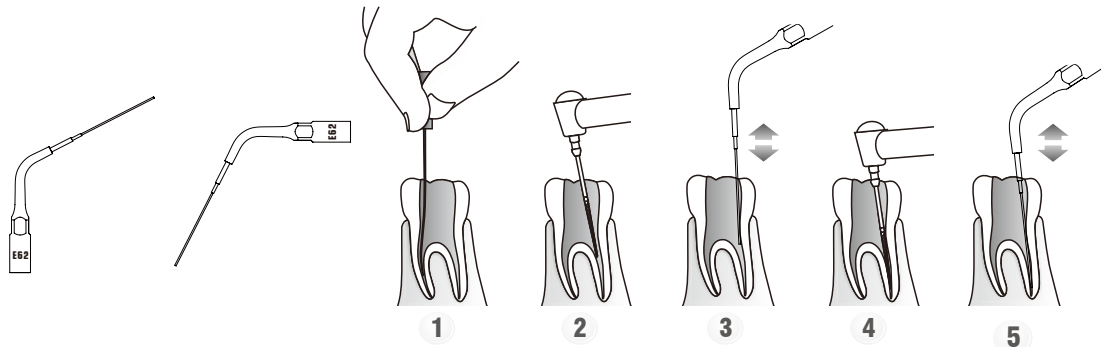

MODE: E
POWER

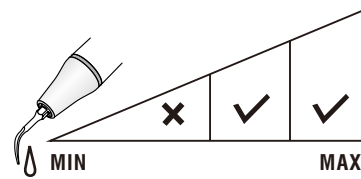
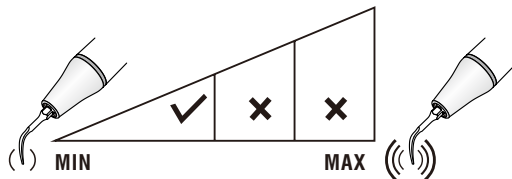

IRRIGATION

E66(ED66)

Function: Used for irrigation of root canal after root canal preparation, so as to rinse out the debris.

Dimensions: Diameter of file tip: \varnothing 0.15mm; taper 2%; length of thread working part: 16mm

Features: The working part has a sharp K-shaped spiral shape, which has strong cutting ability. It can effectively clean out the debris in root canal by using it under low power. Recommended service life: 30~50 root canals

Note: (1) In order to ensure the service life of the tip, it is recommended to use it according to the recommended method: first perform the external debugging, start the foot pedal under power level 1, ensure the water output is normal, and adjust the power (level 1~3) according to individual need to ensure that the water output can reach the tip end (the water can reach the tip end through adjusting water volume). After all the above steps, start root canal irrigation. (2) During irrigation, in order to avoid instrument fracture, please prevent tip from getting stuck and vibrating in root canal. (3) The top edge of ED66 tip is sharp. Please pay special attention to the operation at high power during the irrigation. Otherwise it will cause non-therapeutic damage to the root canal wall.

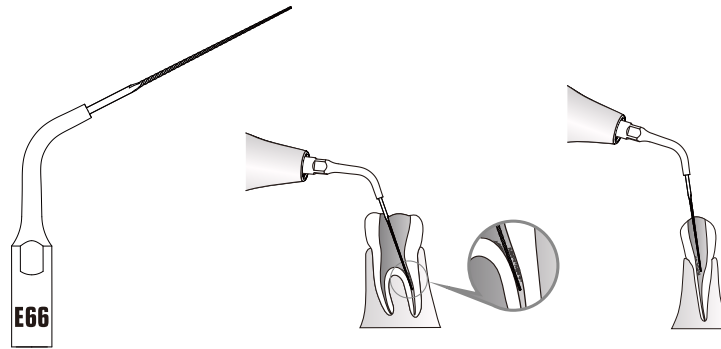

**MODE: E
POWER**

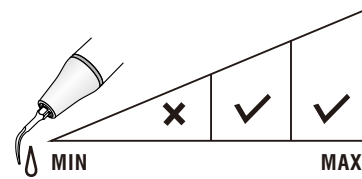
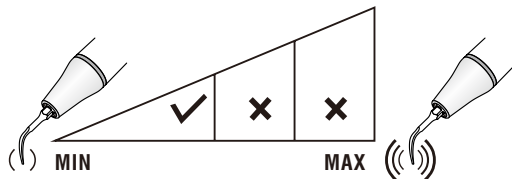

IRRIGATION

SB1 (SBD1)

Diamond-coated(85µm) instrument for removing the caries on occlusal surface of teeth and dental neck.

Place the instrument on the pit and move slowly into it with light pressure.

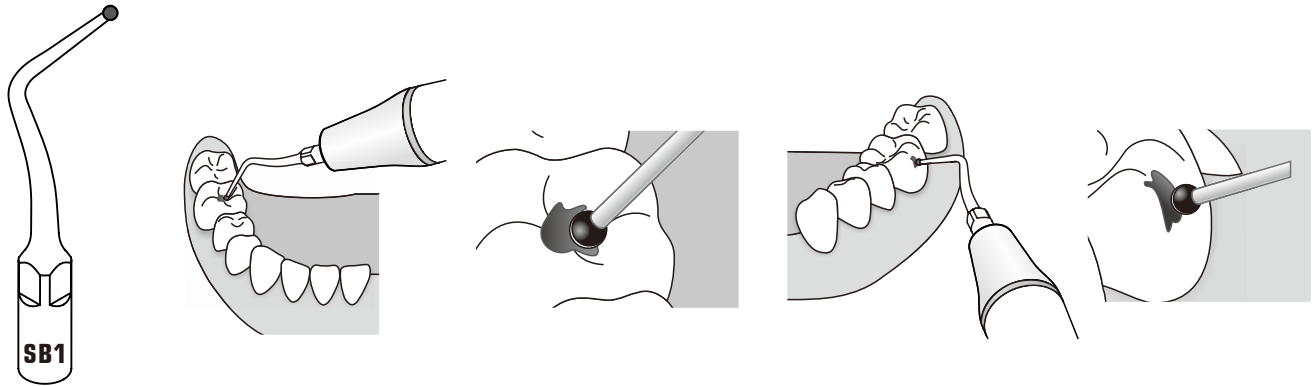

Demo Video

MODE: P
POWER

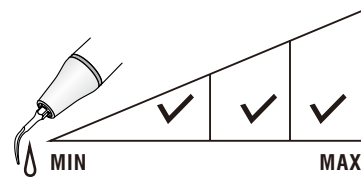
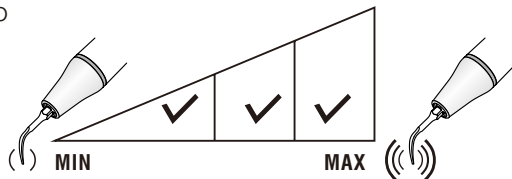

IRRIGATION

SB2 (SBD2)

Diamond-coated(85µm) instrument for removing the caries on Mesial surface of the adjacent teeth.

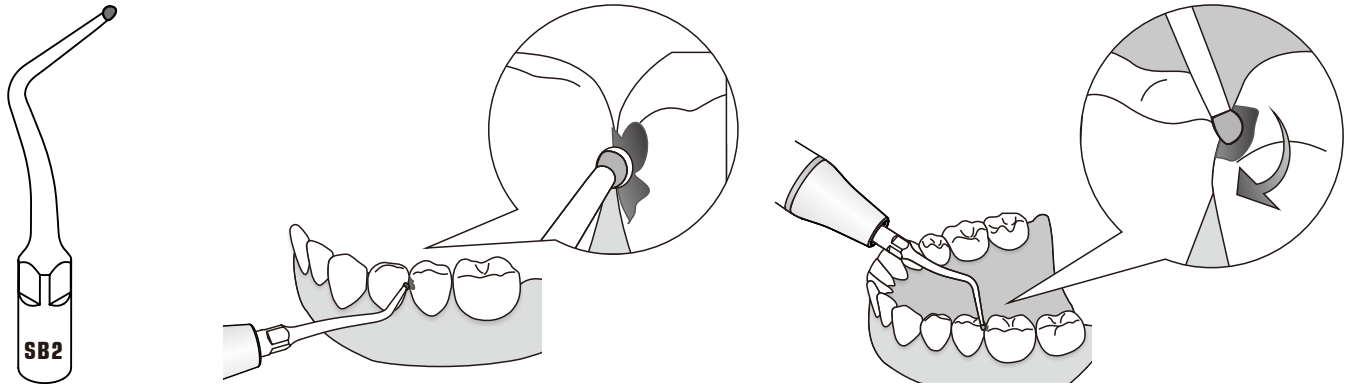

Demo Video

MODE: P
POWER

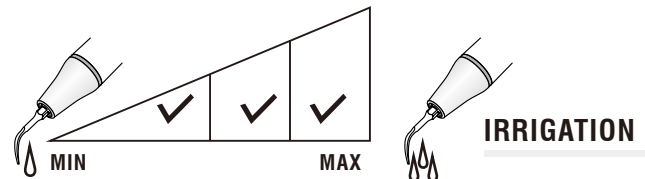
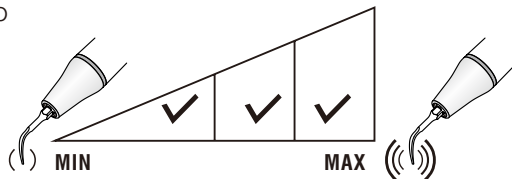

SB3 (SBD3)

Diamond-coated(85µm) instrument for removing the caries on Distal surface of the adjacent teeth.

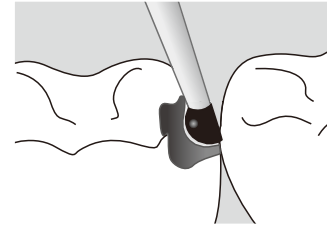
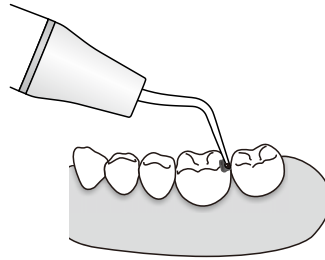
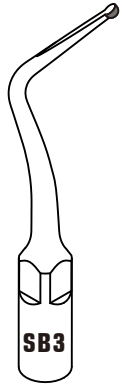

Demo Video

MODE: P
POWER

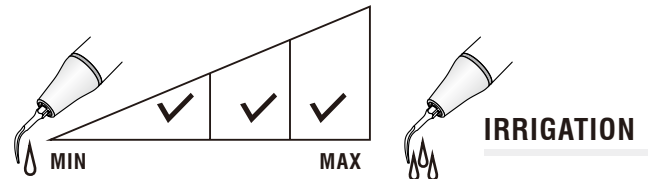
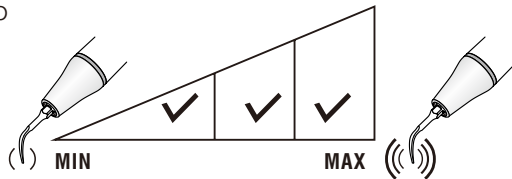

SBL(SBDL)

Diamond-coated(85µm) instrument for removing the dental caries, it will not hurt the adjacent teeth from right to left 45 degree.

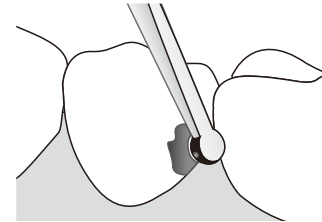
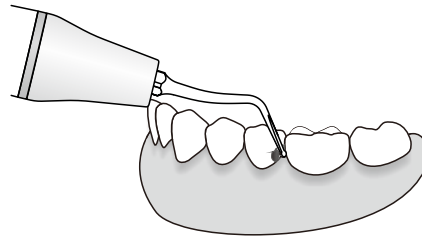
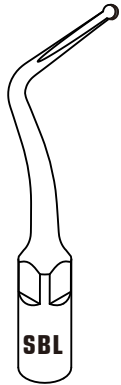

Demo Video

MODE: P
POWER

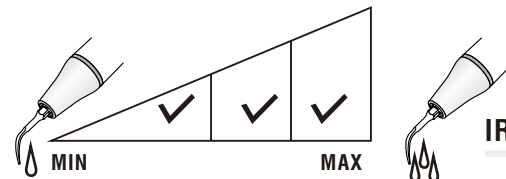
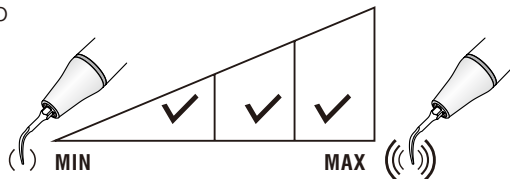

IRRIGATION

SBR (SBDR)

Diamond-coated (85µm) instrument for removing the dental caries, it will not hurt the adjacent teeth from left to right 45 degree.

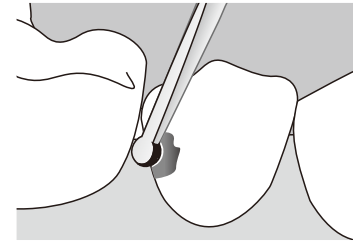
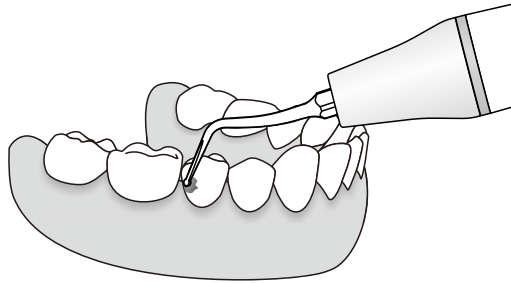
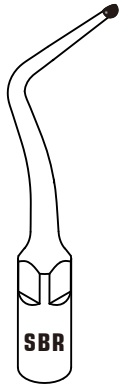

Demo Video

MODE: P
POWER

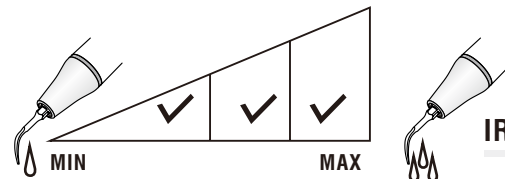
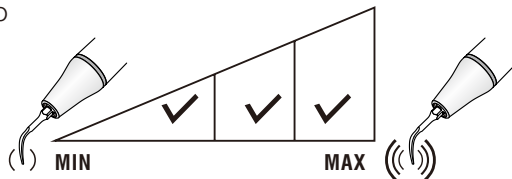

IRRIGATION

GK1

Removal of supragingival deposits in all quadrants.

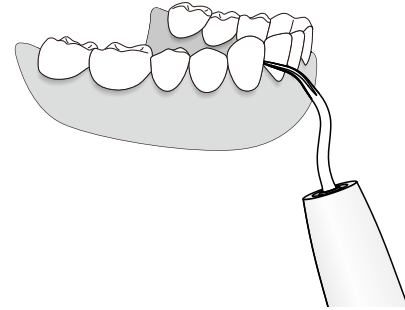
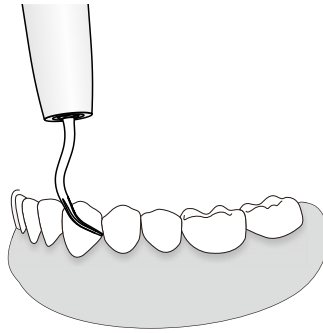

POWER

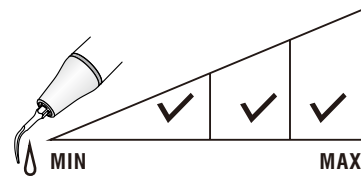
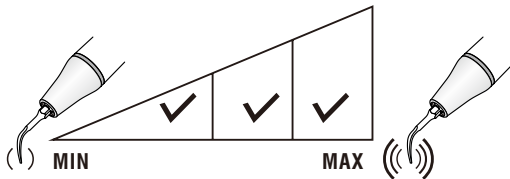

IRRIGATION

GK2

Removal of supragingival heavy calculus and plaque.

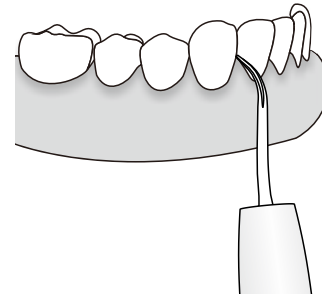
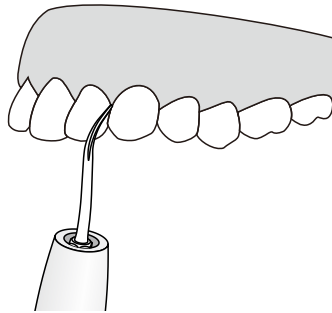

POWER

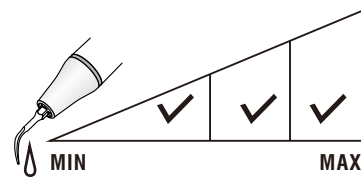
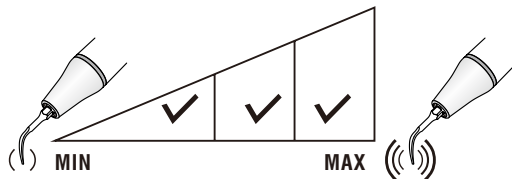

IRRIGATION

GK3

Removal of supragingival calculus, interdental calculus and calculus at the neck of the teeth.

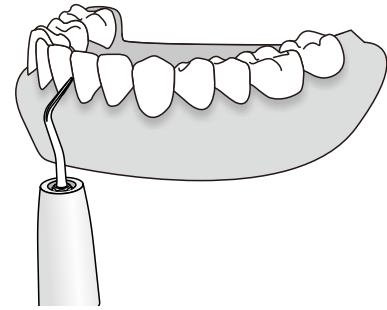
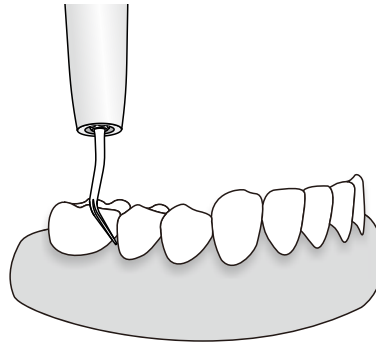
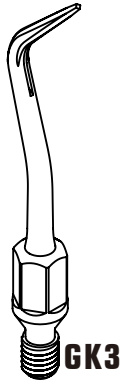

POWER

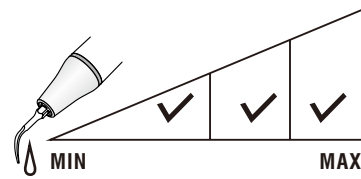
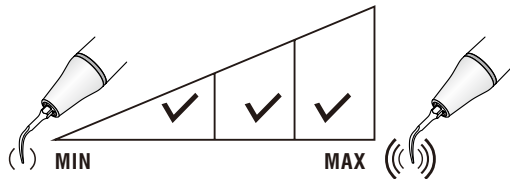

IRRIGATION

GK4

Removal of supragingival deposits, including the interproximal and sulcus areas.

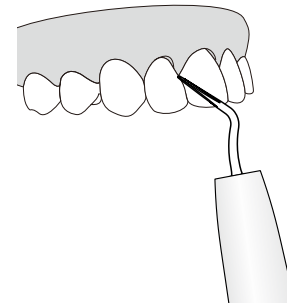
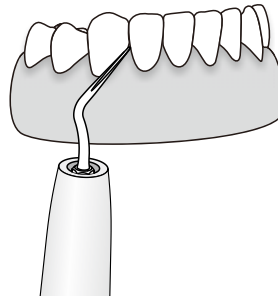
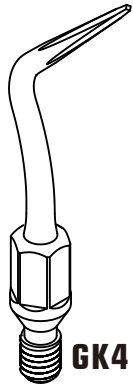

POWER

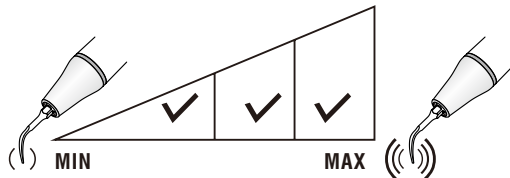

IRRIGATION

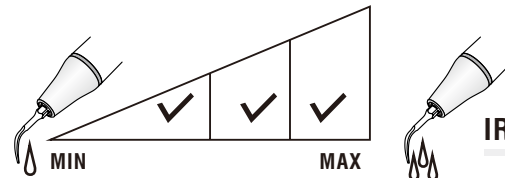

GK5

Removal of subgingival calculus.

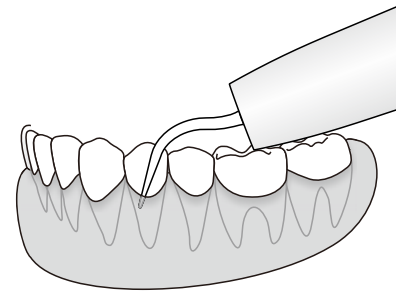
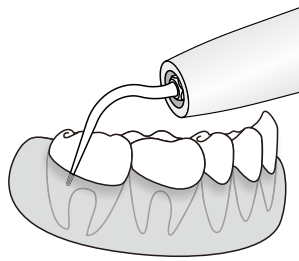
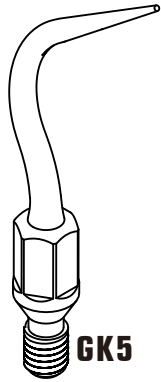

POWER

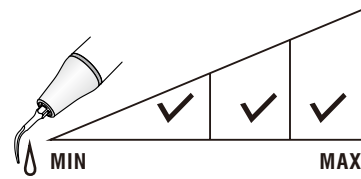
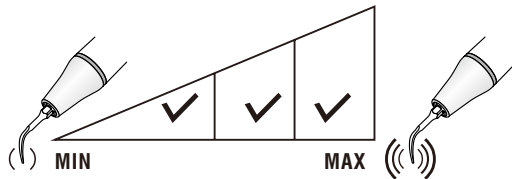

IRRIGATION

GK6

Left-angled, removal of subgingival calculus.

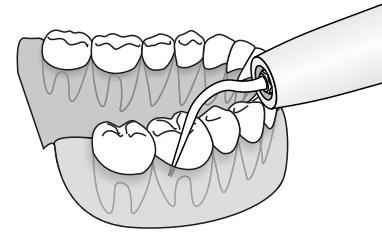
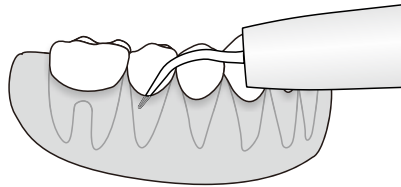
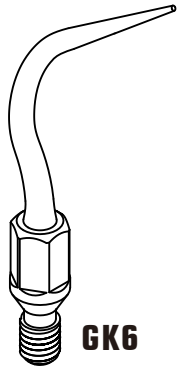

POWER

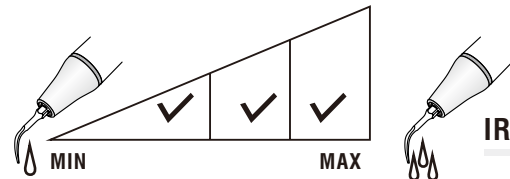
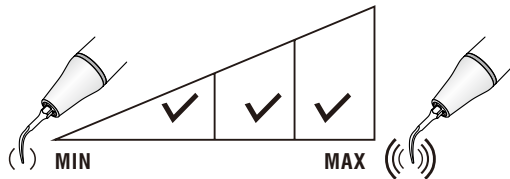

IRRIGATION

GK7

Right-angled, removal of subgingival calculus.

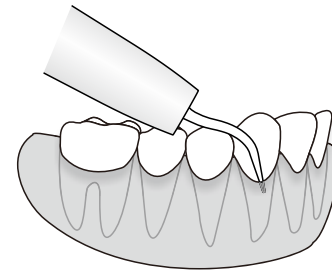
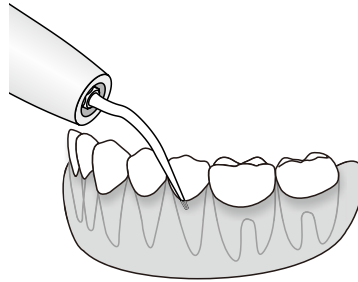
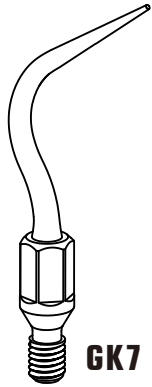

POWER

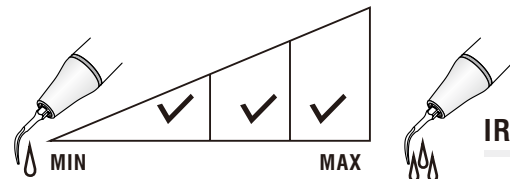
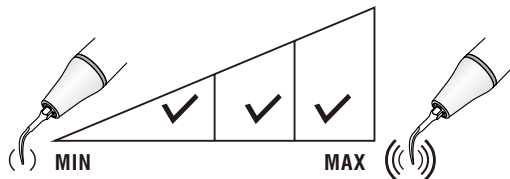

IRRIGATION

Gk20

There are diamonds coated (120um grit) on the head of the tip for dentin abrading.

It's used for "supragingival shoulder" preparation after the completion of the preparation of the "subgingival shoulder" with bur.

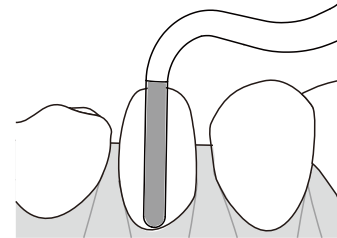
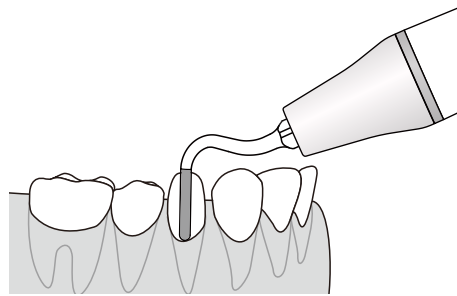
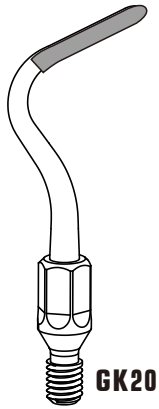

POWER

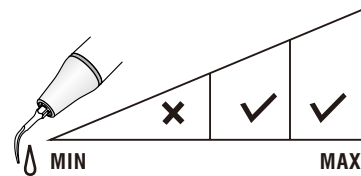
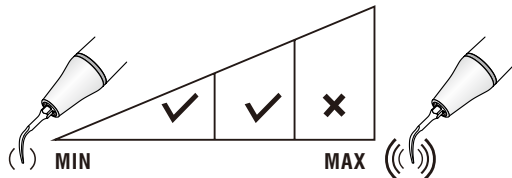

IRRIGATION

Gk21

There are diamonds coated (50um fine sand) on the head of the tip for dentin abrading, mainly used for polishing of prepared supragingival shoulder and subgingival shoulder.

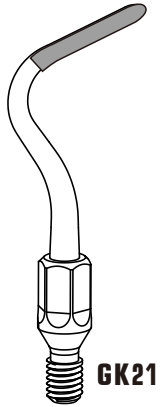

GK21

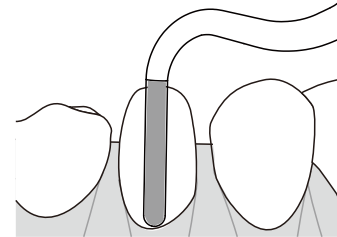
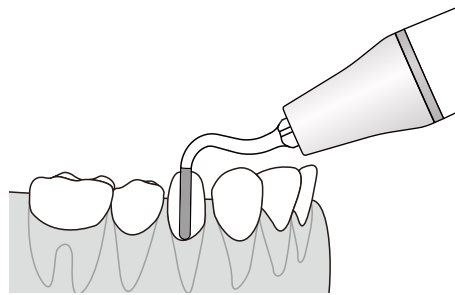

POWER

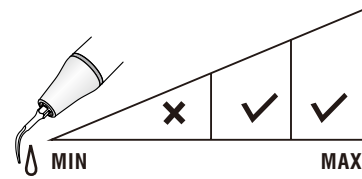
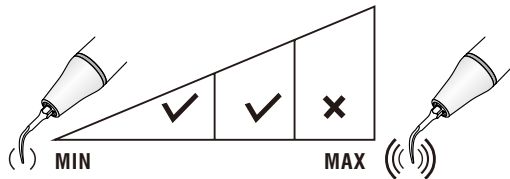

IRRIGATION

GK60

Removal of supragingival deposits in all quadrants.

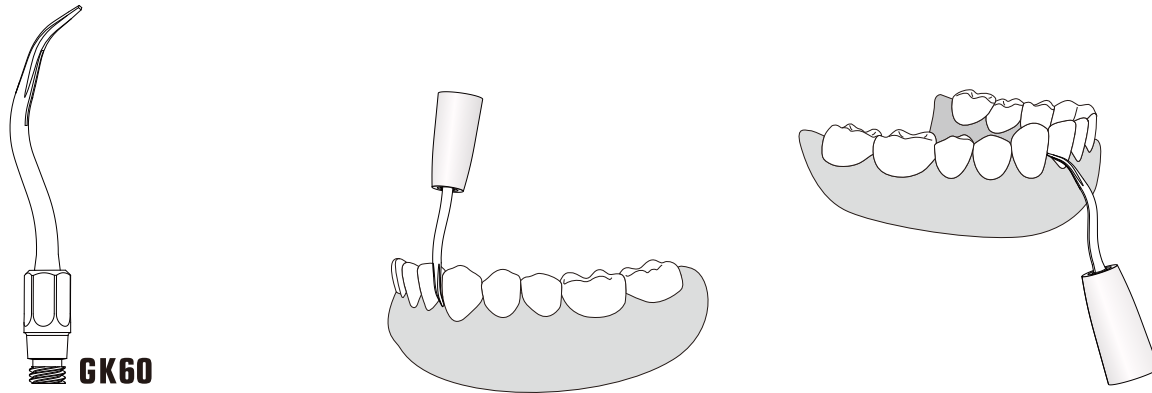

POWER

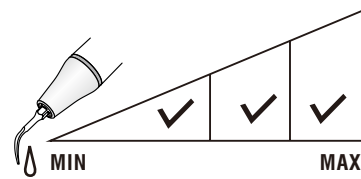
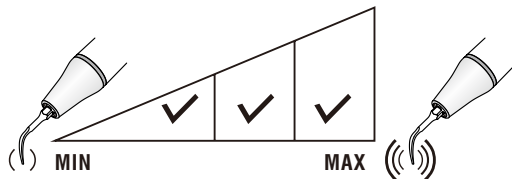

IRRIGATION

GK61

Removal of supragingival heavy calculus and plaque.

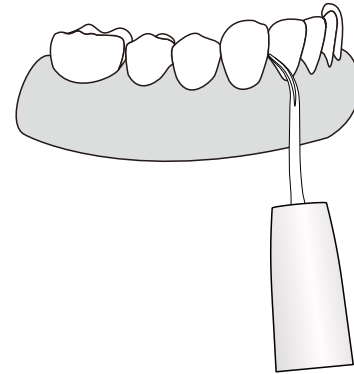
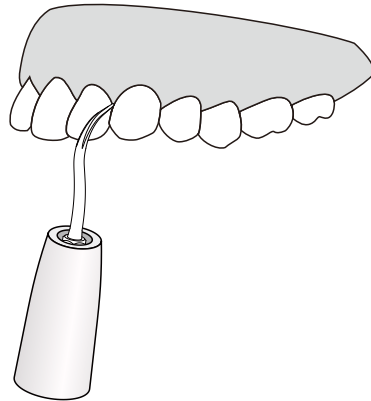
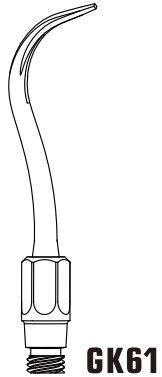

POWER

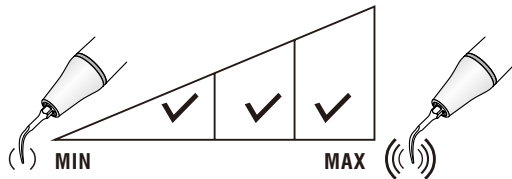

IRRIGATION

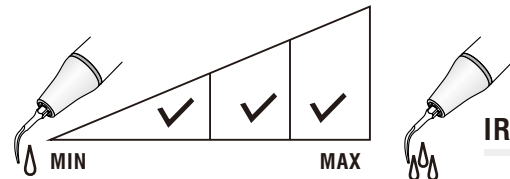

GK62

Removal of supragingival calculus, interdental calculus and calculus at the neck of the teeth.

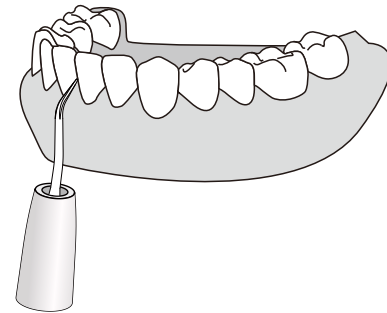
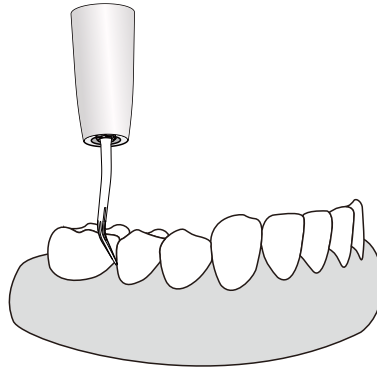
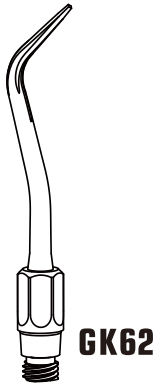

POWER

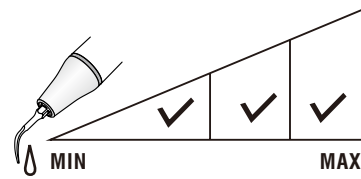
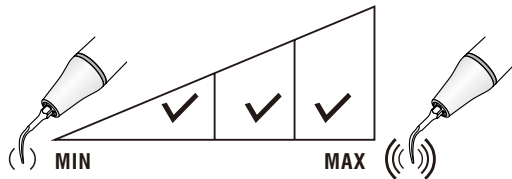

IRRIGATION

GC1

Removal of supragingival deposits in all quadrants.

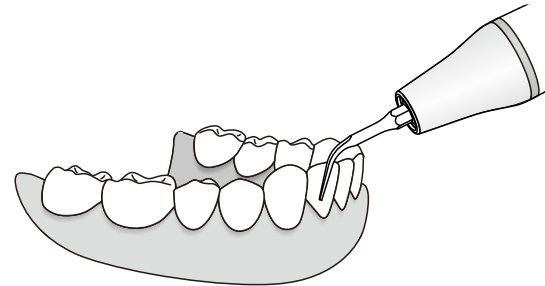
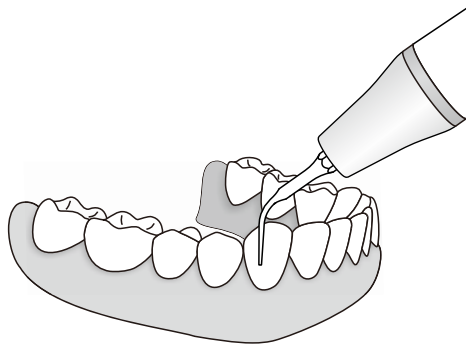
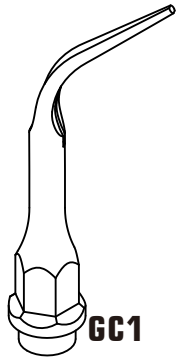

MODE: G
POWER

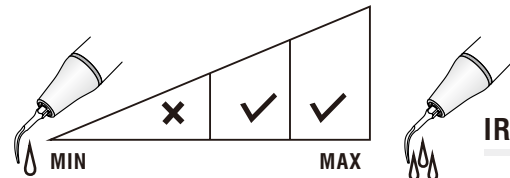
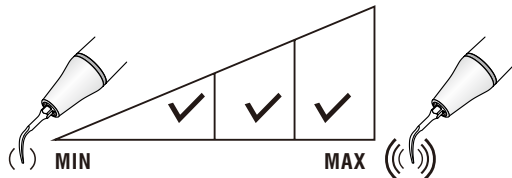

IRRIGATION

GC2

Removal of supragingival calculus, interdental calculus and calculus at the neck of the teeth.

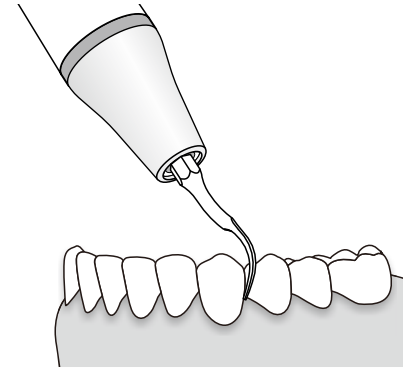
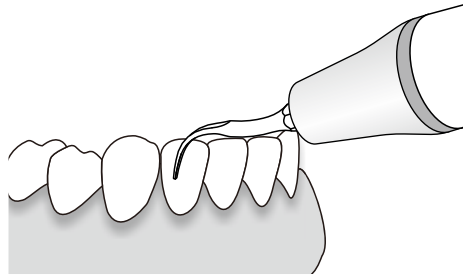

MODE: G
POWER

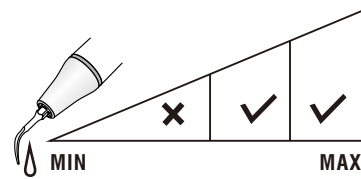
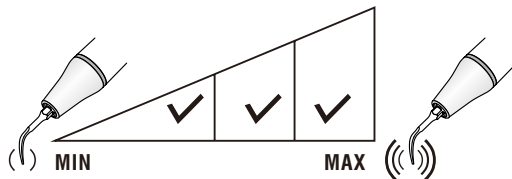

IRRIGATION

PC1

Removal of subgingival calculus, including the interproximal and sulcus areas.

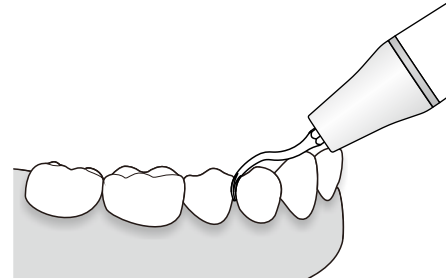
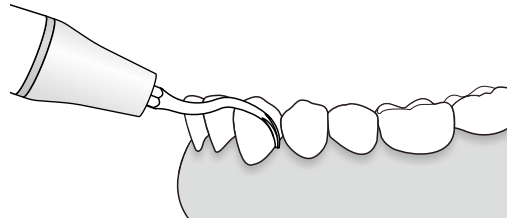
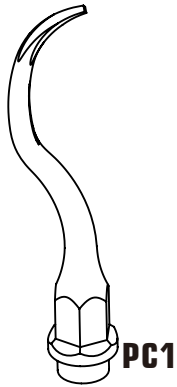

MODE: P
POWER

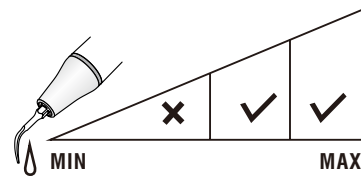
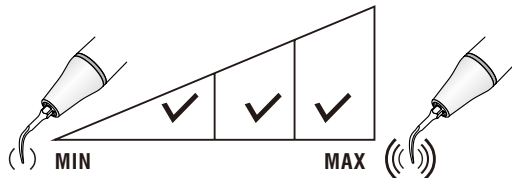

IRRIGATION

PC60

Recommended for the treatment of interproximal spaces and for supragingival scaling.

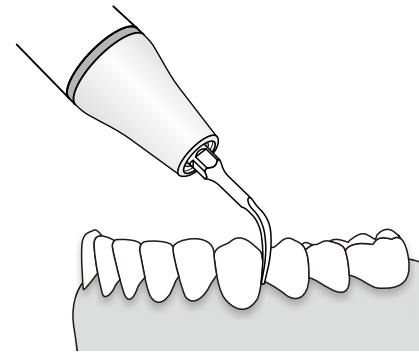
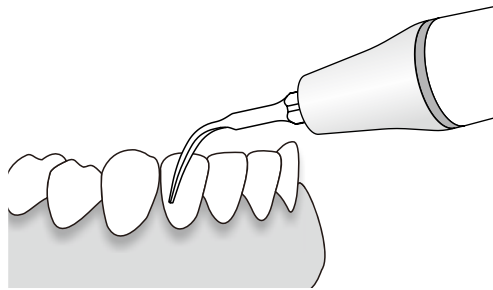
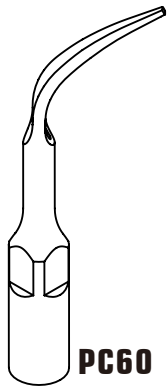

MODE: P
POWER

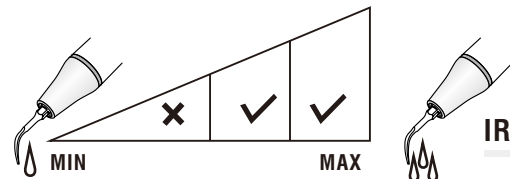
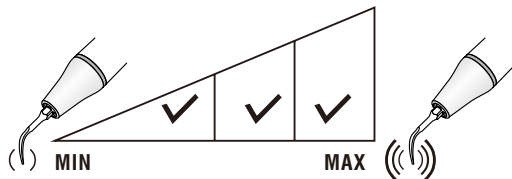

IRRIGATION

PC61

Function: used to remove the calculus at shallow periodontal pocket and treat the adjacent tooth surface and ditch area.

Features: The tip is flat and wide, which can be used to clean the teeth surface at subgingival 1/4 and the supragingival part.

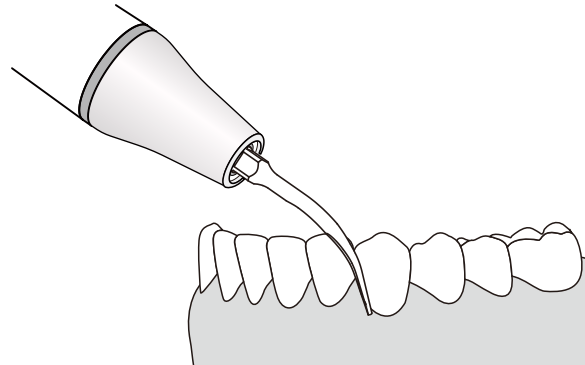
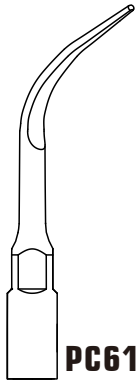

**MODE: P
POWER**

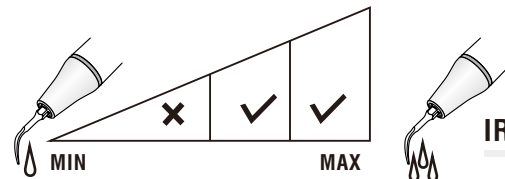
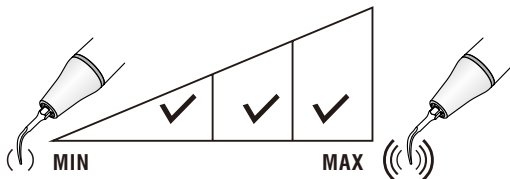

IRRIGATION

PC62

Recommended for cleaning and irrigating of periodontal deep pockets.

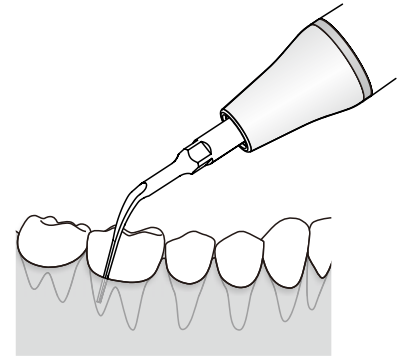
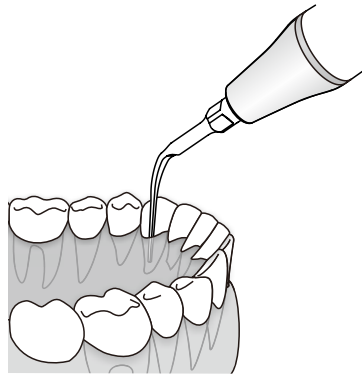
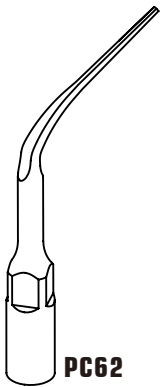

MODE: P
POWER

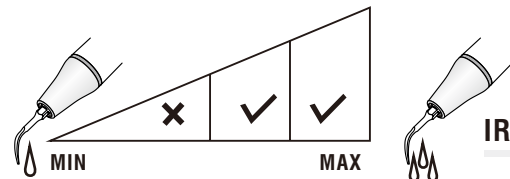
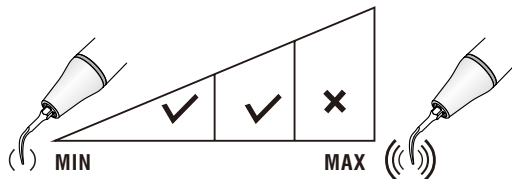

IRRIGATION

A1

Removal of supragingival deposits, including the interproximal and sulcus areas.

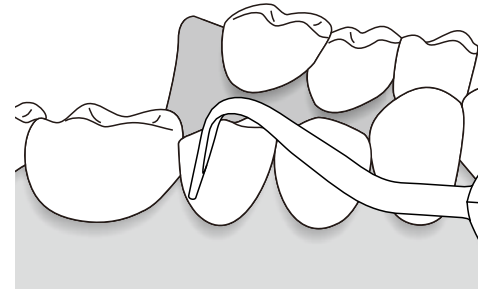
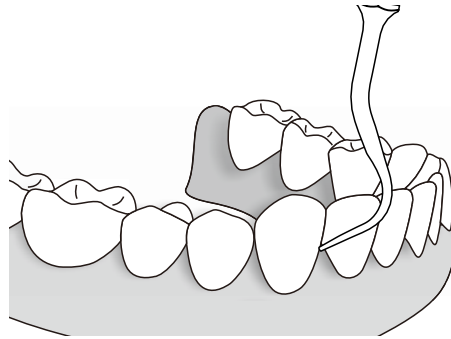
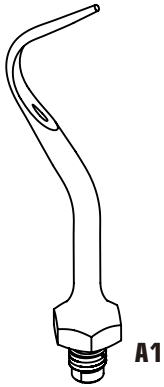

POWER

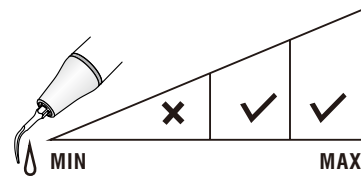
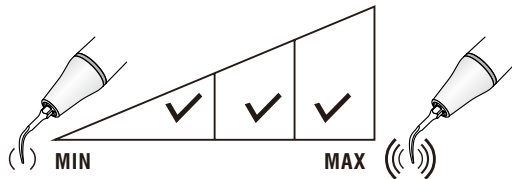

IRRIGATION

A2

Removal of supragingival deposits in all quadrants, including neck and adjacent part of the teeth.

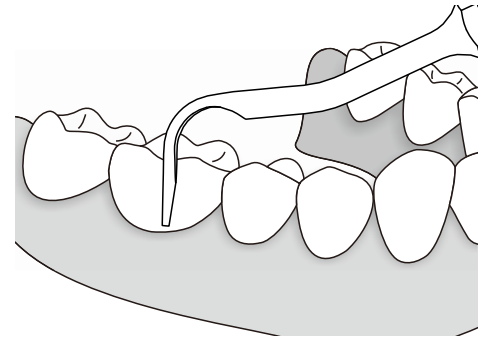
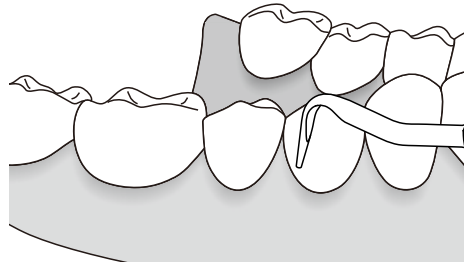
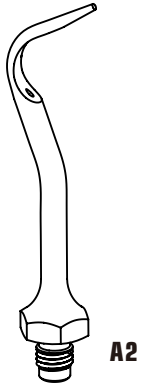

POWER

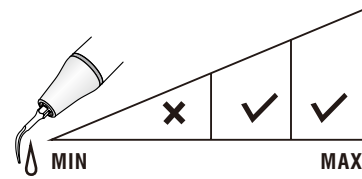
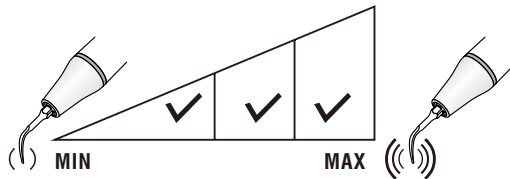

IRRIGATION

Attached list: Other tips

	Tip Model	Compatible Brand
Scaling	GS1/GS2/GS3/GS4/GS5/GS6/GS7/GS8	Compatible with Sirona Scalers
Periodontics	PS1/PS3/PS3D/PS4	
Endodontics	ES1/ES2/ES3/ES3D/ES4/ES4D/ES5/ES5D/ PS4D/ES8/ES10/ES10D/ES11/ES11D/ES14 /ES15	
Scaling	GK1/GK2/GK3/GK4/GK5/GK6/GK7/GK11/ GK20/GK21/GK60/GK61/GK62	Compatible with Kavo Scalers
Endodontics	EK8	
Scaling	GC1/GC2	
Periodontics	PC1/PC61/PC61/PC62	
Scaling	A1/A2	Compatible with Amdent Scalers



www.glwoodpecker.com

DentalDeal



Guilin Woodpecker Medical Instrument Co., Ltd.
Information Industrial Park, Guilin National High-Tech
Zone, Guilin, Guangxi, 541004 P. R. China

Tel:

Europe Sales Dept.: +86-773-5873196, +86-773-2125222

North America, South America &

Oceania Sales Dept.: +86-773-5873198, +86-773-2125123

Asia & Africa Sales Dept.: +86-773-5855350, +86-773-2125896

Fax: +86-773-5822450

E-mail: woodpecker@glwoodpecker.com, sales@glwoodpecker.com

Website: <http://www.glwoodpecker.com>



MedNet GmbH
Borkstrasse 10 · 48163 Muenster · Germany



ZMN/WI-09-036 1. 5-20190427

www.dentaldeal.ca